

# Railway Main Line Cables

NORWAY



## Linking the Future

As the worldwide leader in the cable industry, Prysmian Group believes in the effective, efficient and sustainable supply of energy and information as a primary driver in the development of communities.

With this in mind, we provide major global organisations in many industries with best-in-class cable solutions, based on state-of-the-art technology.

Through two renowned commercial brands - Prysmian and Draka - based in almost 50 countries, we're constantly close to our customers, enabling them to further develop the world's energy and telecoms infrastructures and achieve sustainable and profitable growth.

For our energy business, we design, produce, distribute and install cables and systems for the transmission and distribution of power at low, medium, high and extra-high voltage.

For telecoms, the Group is a leading manufacturer of all types of copper and fibre cables, systems and accessories for voice, video and data transmission.

Drawing on over 130 years' experience and continuously investing in R&D, we apply excellence, understanding and integrity to everything we do, meeting and exceeding the needs of our customers across all continents - while at the same time shaping the evolution of our industry.





# What links global expertise to the wheels of industry?

High-performing cable solutions to keep the wheels of industry turning

On every continent, in applications that range from rolling stock and vehicles for high-speed trains and urban mass transit lines, to all types of rail transport infrastructure, Prysmian's specialist cable solutions sit at the heart of significant international projects - supporting the work of major customers, with high-performing, durable and safe technology.

As the world leader in cabling, we draw on global expertise and local presence to work in close proximity with our customers in order to deliver product and service solutions built on workability, customized solutions and effective supply chain, that help them drive the wheels of industry and achieve sustainable growth and profitability.



# Railway Main Line Cables

## History of the railways

When George Stephenson's steam locomotive "The Rocket" emerged as the winner of the Rainhill Race in 1829, with an average speed of 12.5 mph = 20 km/h, no one could predict the triumphant progress the railways would make in the almost 200 year period that followed. Within just a few decades, the railway developed into a broadly integrated transport system, which drastically reduced travel times, and made it possible to develop infrastructure - especially in the New World on the continent of North America. The triumph of the railways began with a 330 km railway line, as early as 1830. Over the next fifty years, the industry grew exponentially and reached almost 370,000 km. Nowadays, the railway infrastructure extends to more than 1.1 million km.

With the advent of civil aviation, the railway lost its role as the main means of transport for middle and long distances, and has long been regarded as outdated, slow and uncomfortable. But in recent years, the railway has experienced a revival. With the introduction of electronic interlocking technology and agreement on a European system for the management and control of railway transport - ERTMS (European Rail Traffic Management System), the rail transport once again plays an important role especially over medium distances. Thanks to a variety of European and other internationally operating system providers in the field of interlocking technology, the ERTMS system, which originated in Europe, has been experiencing an explosive worldwide acceptance over the past few years.

## Urbanisation

A major challenge for the railways as a means of mass transport, which is also an unparalleled opportunity, is represented by the increasing urbanisation of the world's population. In 2013, approximately 51% of the 7 billion people inhabiting the planet resided in an urban environment. By 2050, not only will the world's population have increased to approximately 9 billion people, but the proportion of people living in cities will have grown to about 70%. Thus, some 6.3 billion inhabitants will reside every day in large cities and be on the move. Car-bound private transport is destined to collapse and a change to rail-based transportation is therefore, without rival.

Tram and metro systems as well as regional trains and light rail vehicles will interconnect the cities into low-emission zones. Megacities are already in planning, such as the Chinese project "Turn The Pearl Delta Into One", in which nine cities with a total of 42 million people are to be merged into a single city. The most modern railway systems will form the backbone of this metropolis. A total of 29 lines with a network of altogether 1500 km will service the region and allow transit times of maximum one hour from one end of town to the other.

## Percentage of urban population and agglomerations by size, class 1980

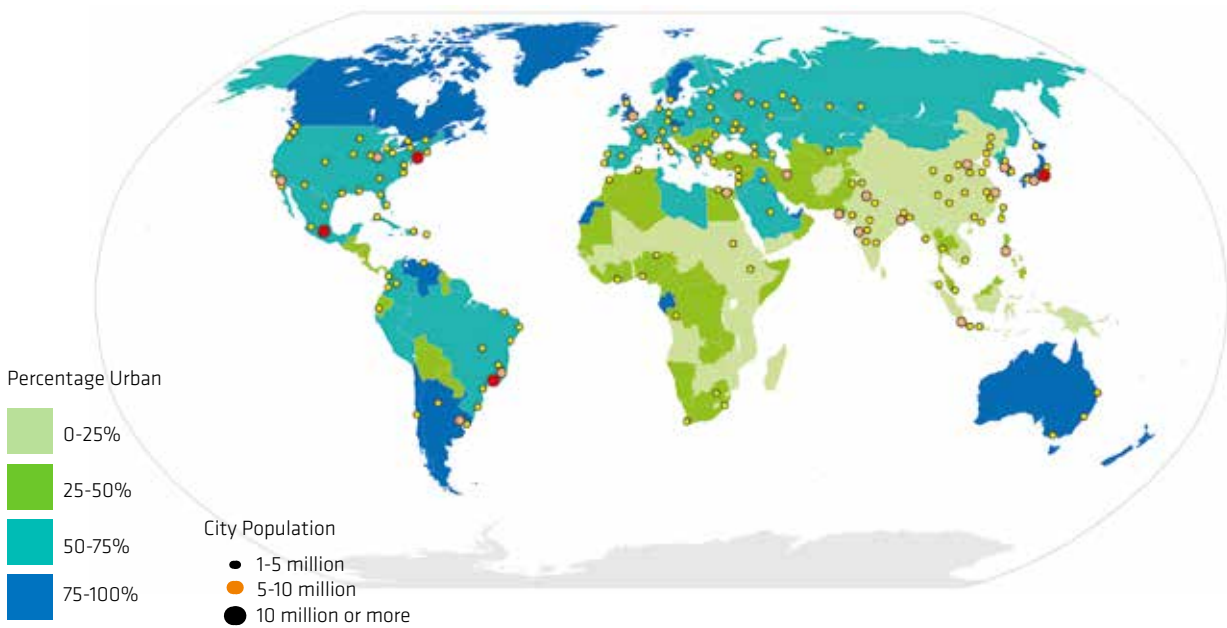

## Percentage of urban population and agglomerations by size, class 2025

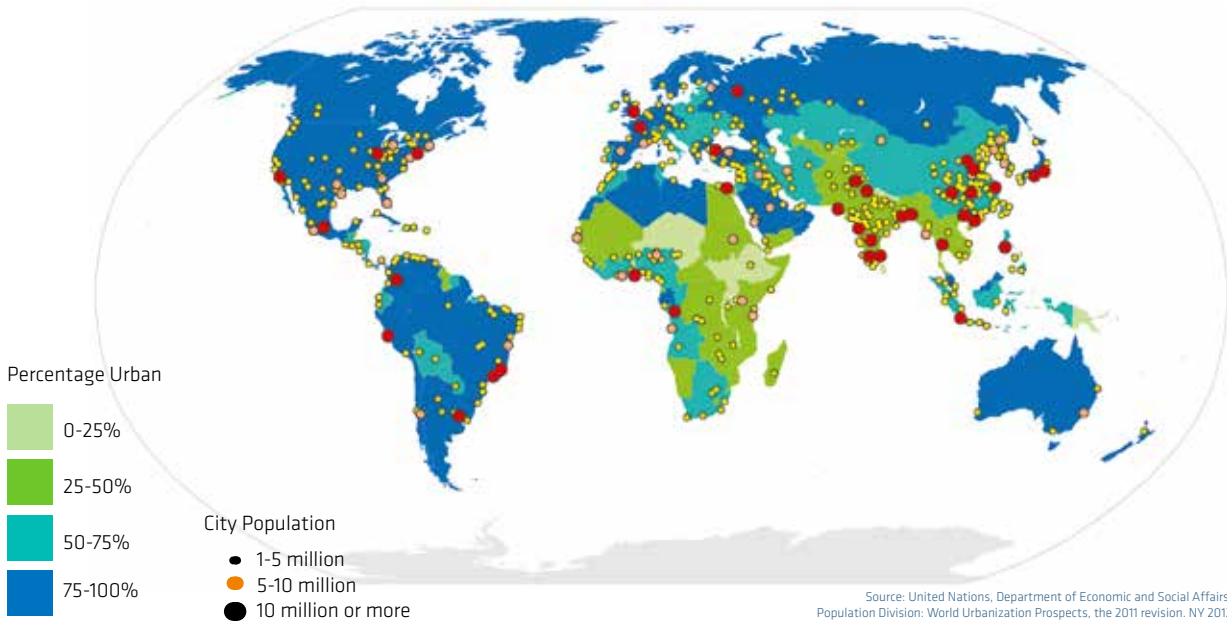

Source: United Nations, Department of Economic and Social Affairs, Population Division: World Urbanization Prospects, the 2011 revision. NY 2012

# Railway Main Line Cables

## Development of technology

The safety requirements for the railway technology are extraordinary and similar to that in aviation or aerospace. With increasing traffic volume in both directions on single track lines, continuous monitoring which provides permanent communication between the train conductor's cab and the railway control center is essential for the railway line safety. The rail vehicles cannot leave their track in case of imminent collision by opposing traffic on the same track.

In Europe, there has been a number of train control technologies that worked well within the country borders, but, led to considerable additional costs in the cross-border traffic. Currently, locomotives have more than one train control system installed, which ensure safe participation in railway traffic in neighboring countries without the need to change the locomotive.

Research aimed at reducing the number of systems and develop a uniform operational management approach for railways across Europe already started in the 80's on behalf of the International Union of Railways (UIC) and the European Rail Research Institute (ERRI). In April 2000, the guidelines for adopting specifications were presented under the name ERTMS - European Rail Traffic Management System.

The ERTMS system mainly consists of the following components:

- ETCS (European Train Control System) is a train control system, which is intended to prevent a train entering an occupied sector, or running at too high speed, using interlocking electronic control systems, with integrated train and trackside elements.

- GSM-R (Global System for Mobile Communications - Railway) is a mobile communications system for railway data and voice communications between moving trains and fixed locations, designed to satisfy the highest safety standards.

ERTMS was initially developed for intercity trains on routes of Trans-European Networks (TEN), but is gaining worldwide attention and it is being implemented outside Europe as well.

Another well recognized railway technology is CBTC - Communication Based Train Control system. CBTC systems are commonly used for urban rail traffic such as underground railways, light rail vehicles and trams, in urban areas with short transportation systems.

Both ETCS and CBTC systems are based on the same principles, namely high safety level in highly dense traffic. However, CBTC goes one step further and offers fully automated train operation. The train starts and stops automatically without a driver.

Even though CBTC complies with international standards the systems of each individual developer are not freely replaceable. The implementation of CBTC is highly complex and significantly more expensive than ERTMS on comparable routes. However, CBTC is unbeatable when it comes to achieving the shortest possible intervals between trains, down to 60-90 seconds. During the peak morning and evening periods, thousands of commuters can be comfortably transported and hence the streets can be relieved of congestion.



Prysmian Group has accompanied this development from the outset and today is able to offer a full range of cables for all applications in the railway sector.

Prysmian Group has the experience and the know-how to assist you and your projects worldwide.

Railway projects are unique!



# Railway Main Line Cables



NSB type 75 - Christian Niclas Nordmark



## Index

|                                                                                     |         |
|-------------------------------------------------------------------------------------|---------|
| Cables for any application                                                          | page 10 |
| Designation codes for cables                                                        | page 12 |
| Explanation of symbols                                                              | page 15 |
| Railway cable data sheets                                                           | page 16 |
| Cables with reduction factor                                                        | page 74 |
| Requirements for fire characteristics of cable installations in tunnels or stations | page 76 |
| Fire testing                                                                        | page 77 |
| Construction Product Regulation                                                     | page 80 |
| Transport and storage of cable drums                                                | page 82 |
| Important physical characteristics                                                  | page 83 |
| Certifications and compliance                                                       | page 84 |
| Our responsibilities                                                                | page 85 |
| References                                                                          | page 86 |

# Railway Main Line Cables

## Cables for any application

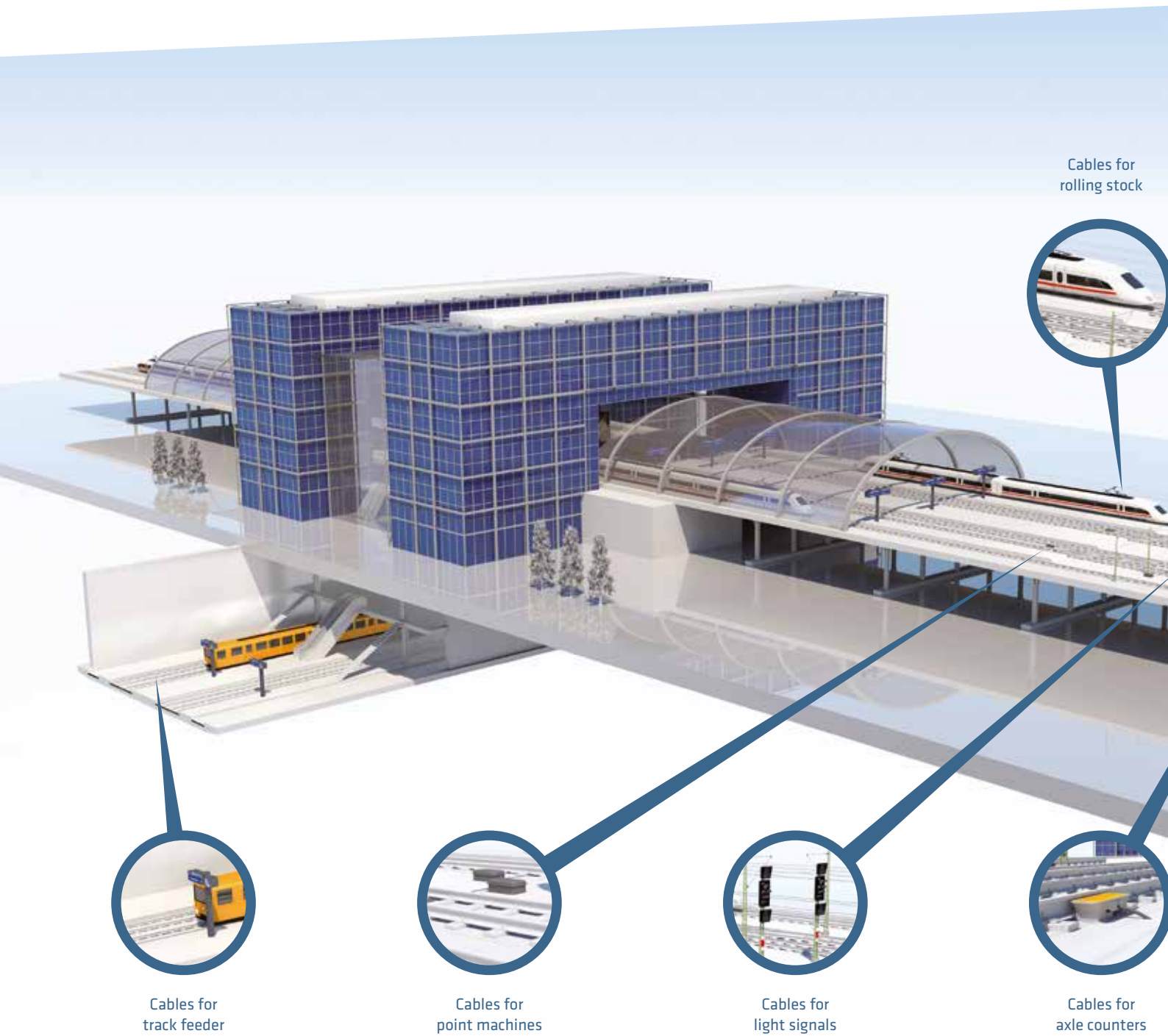

As the leading worldwide supplier, Prysmian Group offers an extensive range of cabling solutions for different railway network applications.

Typical cable applications for main railway lines include:

### **Substations and Transformers**

- HV cables to substations for traction power
- MV cables to transformers for power distribution networks

### **Traction Tower Networks**

- MV cables for AC systems
- MV and LV cables for DC systems

### **Railway Network Systems**

- MV and LV cables to distribute current to control and telecommunication systems, lighting, heating and real estate along the railway.

### **Grounding of Electrical Systems**

- Bare conductors or insulated cables to guarantee the integrity of electrical systems.

### **Overhead Catenary Lines**

- Cables to supply electric power to railway trains and to make them move.

### **Control and Signalling Systems**

- Cables to cover a wide range of control and signalling applications to direct trains and keep trains clear of each other.

### **Mobile Communication Systems (GSM-R)**

- Data and fiber optic cables for railway data and voice communication between moving trains and fixed locations.

Cables for catenary



Cables for balises



# Railway Main Line Cables

## Designation codes for cables

### 1<sup>st</sup> letter: Insulation

- A** Fibre, tight cladding
  - B** Fire resistant tape + insulation (halogen free)
  - C** Polychloroprene (Neoprene) PCP, or chlorinated polyethylene- CPE
  - D** Impregnated paper drip free
  - E** Polyethylene - PE Polypropylene - PP
  - F** PE or PP +
  - G** Filling compound
  - H** Polyamid - PA
  - I** Chlorosulphonated polyethylenen - CSP
  - J** Thermoplastic compound (halogen free)
  - K** Paper
  - L** Air + plastic (coaxial cable)
  - M** Expanded PE or PP + filling compound
  - N** Impregnated paper
  - O** Impregnated paper, oil-filled cable
  - P** Polyvinylchloride - PVC
  - Q** Fiber in loose tube
  - R** Ethylenepropylene rubber - EPR
  - S** Silicone rubber
  - T** Cross-linked polyethylene - XLPE
  - U** Halogen free thermoset compound - EMA or EVA
  - V** Fibre, slotted core
  - W** Other material
  - X** No insulation
  - Y**
  - Z** Flour plastics - PTFE / FEP
- 
- J** Earth conductor
  - O** Optical fibre
  - OJ** Optical fibre and earth conductor

### 2<sup>nd</sup> Letter: Bedding /Inner sheath

- A** Aluminium (optional with corrosion protection)
- B** Corrogated aluminium (o.w.c.p)
- C** Polychloroprene (Neoprene) - PCP or chlorinated polyethylene - CPE
- D** Aluminium + plastics
- E** Polyethylene - PE Polypropylene - PP
- F** Bedding or tape
- G** (Halogen free)
- H**
- I** Chlorosulphonated polyethylene - CSP
- J** Thermoplastic compound (halogen free)
- K** Lead
- L** Aluminium laminate + plastics sheath
- M** Polyyster
- N** Polyurethane
- O** Lead + plastics
- P** Polyvinylchloride - PVC
- Q**
- R** Ethylenepropylene rubber - EPR
- S** Bedding or tape + concentric conductor
- T** PE + aluminium wire + steel tape
- U** Halogen free thermoset compound - EMA or EVA
- V** Aluminium screen
- W** Other materials
- X** No bedding or equivalent
- Y** Screen
- Z** Flour plastics

### 3rd. Letter: Armouring

|          |                                                         |
|----------|---------------------------------------------------------|
| <b>A</b> | Strength member yarn                                    |
| <b>B</b> | Steel tapes, 2 off                                      |
| <b>C</b> | Galvanized steel wire braid                             |
| <b>D</b> | Oil-filled cable reinforced (longitudinal / transverse) |
| <b>E</b> | Oil-filled cable reinforced (transverse only)           |
| <b>F</b> | Flat steel wire armour                                  |
| <b>G</b> |                                                         |
| <b>H</b> |                                                         |
| <b>I</b> | Steel tape + steel wires                                |
| <b>J</b> | Steel tapes                                             |
| <b>K</b> | Steel wire, plastics or rubber coated                   |
| <b>L</b> | Aluminium (laminated to outer jacket)                   |
| <b>M</b> |                                                         |
| <b>N</b> | Steel (laminated to outer jacket)                       |
| <b>O</b> | Copper wire braid (tinned or bare)                      |
| <b>P</b> | Phosphorbronze wire braid                               |
| <b>Q</b> | Steel wires + counter steel tape (optional)             |
| <b>R</b> | Steel wires (round) + filling compound                  |
| <b>S</b> | Concentric conductor (screen)                           |
| <b>T</b> |                                                         |
| <b>U</b> |                                                         |
| <b>V</b> | Double wire armour (two layers)                         |
| <b>W</b> | Catenary wire                                           |
| <b>X</b> | No armour                                               |
| <b>Y</b> |                                                         |
| <b>Z</b> |                                                         |

### 4th. Letter: Outer sheath

|          |                                                                    |
|----------|--------------------------------------------------------------------|
| <b>A</b> | Yarn + bitumen                                                     |
| <b>B</b> | Hydrocarbon resistant sheath                                       |
| <b>C</b> | Polychloroprene (Neoprene) - PCP or chlorinated polyethylene - CPE |
| <b>D</b> |                                                                    |
| <b>E</b> | Polyethylene - PE Polypropylene - PP                               |
| <b>F</b> | Semi-conducting PE                                                 |
| <b>G</b> |                                                                    |
| <b>H</b> | PE + PA                                                            |
| <b>I</b> | Chlorosulphonated polyethylene - CSP                               |
| <b>J</b> | Thermoplastic compound (halogen free)                              |
| <b>K</b> | Lead                                                               |
| <b>L</b> |                                                                    |
| <b>M</b> | Polyester                                                          |
| <b>N</b> | Polyurethane                                                       |
| <b>O</b> |                                                                    |
| <b>P</b> | Polyvinylchloride - PVC                                            |
| <b>Q</b> |                                                                    |
| <b>R</b> | Ethylenepropylene rubber - EPR                                     |
| <b>S</b> | Silicone rubber                                                    |
| <b>T</b> | Cross-linked polyethylene - XLPE                                   |
| <b>U</b> | Halogen free thermoset compound - EMA or EVA                       |
| <b>V</b> | Other halogen free thermoset materials                             |
| <b>W</b> | Other materials                                                    |
| <b>X</b> | No sheath                                                          |
| <b>Y</b> |                                                                    |
| <b>Z</b> | Flour plastics                                                     |

# Railway Main Line Cables



4rail.net: Oslo tram - Ilkka Siissaio



# Explanation of symbols



## Conductor temperature

Max. conductor temperature °C in continuous operation.



## Flexible installation

Due to IEC 60228 class 5 multi-standed conductor.



## Smoke density

Smoke propagation acc. to EN/IEC 61034.



## Halogen free

Halogen free acc. to EN/IEC 60754-1 and EN/IEC 50267-1.



## Acidity

Corrosivity acc. to EN/IEC 60754-2.



## Fire retardant

Flame propagation acc. to EN/IEC 60332-1.  
Bundled and vertical acc. to EN/IEC 60332-3.



## Screened or armoured

With either copper, aluminum or steel wire, foil and tape.



## Fire resistant

Fire resistant acc. to EN/IEC 60331-1 & 2.



## UV resistant

Filling and or outer sheath suitable for outdoor application.



## EMC resistant

Fulfills EMC-directive with 100% dense screen with low coupling impedance.



## Impact resistant

Against shocks.



## Pull resistant

High tensile stress required to create cable failure.



## Weather proof



## Watertight or proof

Axial or radial water blocking via water swellable tape or yarn.

# Railway Main Line Cables

## Index of data sheets

| <b>1</b>   | <b>Electrification of Main Line</b>                                        |                                                                                                           | <b>Page</b>                                                                                                                                               |
|------------|----------------------------------------------------------------------------|-----------------------------------------------------------------------------------------------------------|-----------------------------------------------------------------------------------------------------------------------------------------------------------|
| <b>1.1</b> | <b>Traction power network</b>                                              |                                                                                                           |                                                                                                                                                           |
|            | Cables to feed traction power networks                                     | MV, HF<br>MV, FR                                                                                          | TSLF 36 kV<br>TSLI 36 kV<br>19<br>20                                                                                                                      |
| <b>1.2</b> | <b>Railway network system</b>                                              |                                                                                                           |                                                                                                                                                           |
|            | Current distribution from transformer to different railway network systems | LV, watertight<br>LV, fire resistant<br>LV, FR                                                            | PRO Light 1 kV<br>Firetuf BFSI EMC 1 kV<br>IFSI EMC 1 kV<br>21<br>22<br>23                                                                                |
| <b>1.3</b> | <b>Grounding and inter-connection</b>                                      |                                                                                                           |                                                                                                                                                           |
|            | Grounding of metal part of electrical systems and connection cables        | Annealed copper<br>Annealed copper<br>Hard drawn copper<br>Insulated HF<br>Insulated FR<br>Insulated HFFR | HK<br>KGF<br>KHF<br>IX PURE 450/750 V<br>PN 450/750 V<br>RQ PURE 450/750 V<br>25<br>26<br>27<br>28<br>29<br>30                                            |
| <b>1.4</b> | <b>Accessory</b>                                                           |                                                                                                           |                                                                                                                                                           |
|            | For LV and MV systems                                                      | Multi connector<br>Tee connector<br>Joint<br>Termination<br>Joint<br>Joint                                | FORMFIT 12-36 kV<br>ELASCON 12-36<br>SIXTY-SPEED 72.5 kV<br>COLDFIT 72.5 kV<br>ECOSPEED 24-36 kV<br>ELASPEED 12-36 kV<br>32<br>33<br>34<br>35<br>36<br>37 |
| <b>2</b>   | <b>Overhead Catenary Line</b>                                              |                                                                                                           | <b>Page</b>                                                                                                                                               |
| <b>2.1</b> | <b>Catenary contact wire</b>                                               |                                                                                                           |                                                                                                                                                           |
|            |                                                                            | Pure copper<br>Copper-silver                                                                              | TRL<br>TRL CuAg<br>39<br>40                                                                                                                               |
| <b>2.2</b> | <b>Catenary wire</b>                                                       |                                                                                                           |                                                                                                                                                           |
|            |                                                                            | Bronze alloyed                                                                                            | KK Bz-II 50 mm <sup>2</sup><br>41                                                                                                                         |
| <b>2.3</b> | <b>Dropper</b>                                                             |                                                                                                           |                                                                                                                                                           |
|            |                                                                            | Bronze alloyed<br>Multi-stranded                                                                          | KK Bz-II 10 mm <sup>2</sup><br>KKM Bz-II 10 mm <sup>2</sup><br>41<br>42                                                                                   |
| <b>2.4</b> | <b>Return wire</b>                                                         |                                                                                                           |                                                                                                                                                           |
|            |                                                                            | Al conductor<br>Al/steel conductor<br>Insulated HFFR<br>Insulated flexible                                | AAC<br>ACSR<br>IXXI 1 kV<br>RZ1-k Afumex Easy 1 kV<br>43<br>44<br>45<br>46                                                                                |

# Popular railway cable data sheets

## Index of data sheets

| <b>3</b>   | <b>Signalling &amp; Control System</b> |              | <b>Page</b>                |
|------------|----------------------------------------|--------------|----------------------------|
| <b>3.1</b> | <b>Signalling</b>                      |              |                            |
|            |                                        | Balise cable | L1-MEBI-45P 48             |
|            |                                        | Balise cable | A-2YTF(L)H(SR)H 49         |
|            |                                        | Gel filled   | FEBI 50                    |
|            |                                        | Axle counter | FTGS 51                    |
| <b>3.2</b> | <b>Control</b>                         |              |                            |
|            |                                        | EMC screen   | IFSI-EMC PURE 300/500 V 52 |
|            |                                        | EMC screen   | IFSI-EMC PURE 450/750 V 53 |

| <b>4</b>   | <b>Communication</b>   |                    | <b>Page</b>                   |
|------------|------------------------|--------------------|-------------------------------|
| <b>4.1</b> | <b>Along the track</b> |                    |                               |
|            |                        | Direct buried      | QENE 55                       |
|            |                        | Direct buried/duct | AINI 56                       |
|            |                        | Direct buried/duct | AIAI 57                       |
|            |                        | Direct buried/duct | QXAE 58                       |
|            |                        | Direct buried/duct | QINI 59                       |
|            |                        | Duct               | QXXE-0/DT-JM/W 60             |
|            |                        | Duct               | QANE 61                       |
|            |                        | Duct               | QXXI-I/O 62                   |
| <b>4.2</b> | <b>Aerial</b>          |                    |                               |
|            |                        | Aerial/duct        | QEAE KOMBI 63                 |
|            |                        | Aerial             | QXWE-7.0 64                   |
| <b>4.3</b> | <b>Connectivity</b>    |                    |                               |
|            |                        | 19" universal      | ORP 250 Distribution Panel 66 |
|            |                        | 19" universal      | ORP 260 Distribution Panel 67 |
|            |                        | IP68               | XOK Joint Closure 68          |
|            |                        | Indoor IP54        | PK-300 Termination Box 69     |
|            |                        | Indoor             | PK-100 Termination Box 70     |
|            |                        | Indoor             | PK-100A Termination Box 71    |
|            |                        | Outdoor            | PK-107 Termination Box 72     |
|            |                        | Indoor             | PK-200 Termination Box 73     |

Many more cable types and tailor-made cables are available for your individual application.





NSB Dovrebanen - Leif Olestad



## TRACTION POWER NETWORK

# TSLF 18/30 (36) kV

## SCREENED & WATER PROOF

### Application

Single core distribution cable suitable for installation outdoors in soil, air and water. The cable is vertical and horizontally water-proof and can be loaded according to NEN 62.75. Outer sheath of semi-conductive material enables electrical testing of the sheath and detection of sheath damage. For indoor installation the cables must be painted with fire-retardant paint or laid in a duct.

### Technical data

#### Rated voltage:

- > 18/30 (36) kV

#### Test voltage:

- > Max 125 kV

#### Bending radius:

- > During installation: 10 x D
- > Fixed: 15 x D

### Temperature range

- > Max. conductor temperature: +90°C
- > Lowest temp. at installation: -20°C
- > Below 0°C exercise caution

### Standard & Directive

- > HD 620 part 10, section K and M
- > Fulfills RoHS & REACH

### Construction

#### Conductor:

- > Multi-stranded aluminium
- > Compressed and round
- > Class 2. acc. to IEC 60228
- > Axially waterproof

#### Conductor screen:

- > Extruded semi-conductive

#### Insulation:

- > XLPE, minimum 7.1 mm

#### Insulation screen:

- > Semi-conductive layer, fixed

#### Axial water barrier:

- > Semi-conductive water swelling tape

#### Screen:

- > Annealed copper wires

#### Radial water barrier:

- > Aluminium-PE laminate, fixed

#### Outer sheath:

- > PE, transparent and UV resistant

#### Conductive layer:

- > Semi-conductive & double extruded
- > Black

### Material property

- > Halogen free: EN 60754-1
- > Acidity: EN 60754-2 Application



90°



Content is subject to changes acc. to current product development and or any changes to standards.

| Conductor cross-section mm <sup>2</sup> | Diameter over insulation mm | Outer diameter mm | Weight kg/km | Standard length m | Prysmian EAN no. |
|-----------------------------------------|-----------------------------|-------------------|--------------|-------------------|------------------|
| 1 x 50/16                               | 24.3                        | 33.0              | 970          | 1000 - K20        |                  |
| 1 x 70/16                               | 25.9                        | 34.5              | 1,080        | 1000 - K20        |                  |
| 1 x 95/25                               | 27.6                        | 36.5              | 1,210        | 1000 - K20        | 7330384713665    |
| 1 x 120/25                              | 28.9                        | 37.5              | 1,390        | 1000 - K20        |                  |
| 1 x 150/25                              | 30.5                        | 39.5              | 1,545        | 1000 - K22        |                  |
| 1 x 185/35                              | 32.2                        | 41.0              | 1,700        | 1000 - K22        | 7330384713658    |
| 1 x 240/35                              | 34.4                        | 43.5              | 1,910        | 1000 - K24        |                  |
| 1 x 300/35                              | 36.9                        | 46.0              | 2,215        | 1000 - K24        | 7330384713689    |
| 1 x 400/35                              | 40.1                        | 49.5              | 2,545        | 1000 - K24        | 7330384713702    |
| 1 x 500/35                              | 43.0                        | 52.5              | 2,920        | 1000 - K26        | 7330384713672    |
| 1 x 630/50                              | 46.9                        | 57.0              | 3,630        | 1000 - K26        | 7330384716772    |
| 1 x 800/50                              | 50.4                        | 60,5              | 4,230        | 1000 - K26        |                  |

# 1. Electrification of main lines

## TRACTION POWER NETWORK

### TSLI 18/30 (36) kV

#### FLAME RETARDANT & WATER PROOF

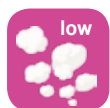

#### Application

Halogen free and flame retardant distribution cable for indoor use in 3-phase installations. Can be placed in pipes or directly in the ground. The cable is axially and radially waterproof.

#### Technical data

##### Rated voltage:

- > 18/30 (36) kV AC

##### Test voltage:

- > 125 kV AC

##### Bending radius:

- > During installation: 10 x D
- > Fixed: 15 x D

#### Temperature range

- > Max. conductor temperature: +90°C
- > Short circuit temperature: +250°C
- > Lowest temp. at installation: -20°C
- > Below 0°C exercise caution

#### Standard & Directive & Approval

##### Standard:

- > H 620 part 10 section K and M
- > HD 604 halogen free sheath

##### Directive:

- > Fulfills RoHS and REACH

##### Approval:

- > CPR class: Dca-s2d2a2

#### Construction

##### Conductor:

- > Round and compressed
- > Stranded aluminium wires
- > Class 2. acc. to IEC 60228
- > Axially watertight

##### Conductor screen:

- > Extruded semi-conductive

##### Insulation:

- > XLPE, minimum 7.1 mm

##### Insulation screen:

- > Extruded semi-conductive
- > Fixed

##### Axial water barrier:

- > Semi-conductive water swelling tape

##### Screen:

- > Concentrically applied
- > Annealed copper wires

##### Radial water barrier:

- > Aluminium/PD laminate, fixed

##### Outer sheath:

- > Halogen free polymer
- > Fire-retardant
- > Black

#### Material property

- > Flame retardant: EN 60332-3-24
- > Halogen free: IEC 60754-1
- > Acidity: EN 60754-2
- > Smoke density: EN 60134

Content is subject to changes acc. to current product development and or any changes to standards.

| Conductor cross-section mm <sup>2</sup> | Diameter over insulation mm | Outer diameter mm | Weight kg/km | Standard length m | Prysmian article no. |
|-----------------------------------------|-----------------------------|-------------------|--------------|-------------------|----------------------|
| 1 x 50/16                               | 24.3                        | 32.5              | 1,061        | 1000 - K18        | 1060224              |
| 1 x 70/16                               | 25.9                        | 34.0              | 1,176        | 1000 - K20        | 1060225              |
| 1 x 95/25                               | 27.6                        | 36.0              | 1,318        | 1000 - K20        | 1060226              |
| 1 x 120/25                              | 28.9                        | 37.5              | 1,506        | 1000 - K20        | 1060227              |
| 1 x 150/25                              | 30.5                        | 39.0              | 1,670        | 1000 - K22        | 1060229              |
| 1 x 185/35                              | 32.2                        | 40.5              | 1,830        | 1000 - K22        | 1060230              |
| 1 x 240/35                              | 34.4                        | 43.0              | 2,059        | 1000 - K24        | 1060231              |
| 1 x 300/35                              | 36.9                        | 46.0              | 2,379        | 1000 - K24        | 1060232              |
| 1 x 400/35                              | 40.1                        | 49.5              | 2,737        | 1000 - K24        | 1060233              |
| 1 x 500/35                              | 43.0                        | 52.5              | 3,135        | 1000 - K26        | 1060234              |
| 1 x 630/50                              | 46.9                        | 56.5              | 3,872        | 1000 - K26        | 1060235              |
| 1 x 800/50                              | 50.4                        | 60.5              | 4,510        | 1000 - K26        | 1060236              |

## RAILWAY NETWORK SYSTEM

# PRO LIGHT 0.6/1 kV

## DOUBLE INSULATED & WATERTIGHT

### Application

Halogen free and flame retardant cable with low smoke emission that is not harmful to electrical equipment. Double insulated cable for fixed installation indoors and outdoors, in pipes or directly in the ground or water. Not for use in hazardous areas. Can be ploughed down. UV resistant. The core colors are UV protected.

### Technical data

#### Rated voltage:

- > 0,6/1 kV

#### Test voltage:

- > 4,000 V AC

#### Bending radius:

- > During installation: 12 x D
- > Fixed: 8 x D

### Temperature range

- > Max. conductor temperature: +90°C
- > Short circuit temperature: +250°C
- > Lowest temp. at installation: -20°C
- > Below 0°C exercise caution

### Standard & Approval

#### Standard:

- > SS 424 14 18 partly
- > HD 603-5M - insulation
- > SS EC 60502 partly

#### Approval:

- > CPR class: E
- > DoP no: 1004222

### Construction

#### Conductor:

- > Round
- > Annealed copper wires
- > Stranded acc. to EN 60228 class 2.

#### Insulation:

- > Cross-linked XLPE

#### Core colours:

- > Yellow/green, blue, brown, black, grey

#### Wrapping:

- > Plastic tape

#### Outer sheath:

- > Halogen free polymer
- > Flame retardant
- > Green

### Material property

- > Halogen free: IEC 60754-1
- > Acidity: IEC 60754-2
- > Flame retardant: IEC 60332-1 & 3
- > Smoke density: EN 60134
- > UV-resistant

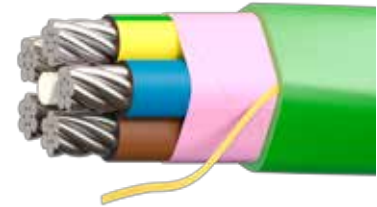

90°

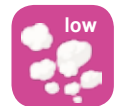

Content is subject to changes acc. to current product development and or any changes to standards.

| Conductor cross-section mm <sup>2</sup> | Conductor diameter mm | Diameter over insulation mm | Outer diameter mm | Weight kg/km | Standard length m | Prysmian EAN no. |
|-----------------------------------------|-----------------------|-----------------------------|-------------------|--------------|-------------------|------------------|
| 5 G 25                                  | 5.8                   | 7.70                        | 25 ± 1.0          | 610          | 500               | 4741532900531    |
| 5 G 50                                  | 8.0                   | 10.10                       | 32 ± 1.5          | 1,056        | 500               | 4741532900555    |
| 5 G 95                                  | 11.2                  | 13.50                       | 41.5 ± 2.0        | 1,867        | 500               | 4741532900517    |



## RAILWAY NETWORK SYSTEM

# FIRETUF BFSI EMC 0.6/1 kV

## EMC & FIRE RESISTANT



### Application

Fire resistant cable for installation in places where electrical performance must be maintained during a fire. The copper screen is 100% dense with low coupling impedance and fulfills the EMC directive. Applicable indoors and outdoors with extra protection against UV radiation or sunlight or as a grounding cable without additional protection.

### Technical data

#### Rated voltage:

- > 0.6/1 kV

#### Test voltage:

- > 4,000 V

#### Bending radius:

- > During installation: 12 x D
- > Fixed: 8 x D

### Temperature range

- > Max. conductor temperature: +90°C
- > Short circuit temperature: +250°C
- > Lowest temp. at installation: -15°C

### Standard & Directive

#### Standard:

- > HD 604-5D
- > IEC 60502/1 halogen free materials
- > HD 308 S2 - core colours
- > EN 50200, EN 50362 (90 min 830°C)

#### Directive:

- > Fulfills RoHS and REACH

### Construction

#### Conductor:

- > Round
- > Copper wires acc. to IEC 60228
- > 1.5-2.5 mm<sup>2</sup> - solid round class 1.
- > 4-25 mm<sup>2</sup> - stranded class 2.
- > 35-150 mm<sup>2</sup> - stranded and sector shaped class 2.

#### Insulation:

- > Mica tape
- > Cross-linked XLPE polymer
- > Halogen free

#### Filler /Wrapping:

- > Halogen free tape or compound

#### Screen:

- > Copper foil with overlap
- > Helix of copper wires
- > 100% coverage
- > Fulfills EMC-directive

#### Outer sheath:

- > Halogen free polymer
- > UV resistant
- > Orange

### Material property

- > Fire resistant: IEC 60331-1 & 2 (90 min)
- > Halogen free: IEC 60754-1
- > Smoke density: IEC 61034-1 & 2
- > Acidity: IEC 60754-2

Content is subject to changes acc. to current product development and or any changes to standards.

| Conductor cross section mm | Conductor type | Outer diameter mm | Weight nom. kg/km | Prysmian article no. |
|----------------------------|----------------|-------------------|-------------------|----------------------|
| 2 x 1,5/1,5                | ER             | 13.5 ± 0.8        | 252               | 20098051             |
| 2 x 2,5/2,5                | ER             | 14 ± 0.8          | 297               | 20098048             |
| 2 x 6/6                    | FR             | 17.5 ± 0.8        | 491               | 20098054             |
| 3 x 1.5/1.5                | ER             | 14 ± 0.8          | 276               | 20098052             |
| 3 x 2.5/2.5                | ER             | 15 ± 0.8          | 330               | 20098049             |
| 3 x 4/4                    | FR             | 17 ± 0.8          | 442               | 20098059             |
| 3 x 6/6                    | FR             | 18 ± 0.8          | 556               | 20098055             |
| 3 x 10/10                  | FR             | 21 ± 1.0          | 803               | 20098057             |
| 3 x 16/16                  | FR             | 23.5 ± 1.0        | 1112              | 20098058             |
| 3 x 25/16                  | FR             | 28.5 ± 1.0        | 1630              | 20081184             |
| 3 x 50/25                  | FV             | 27 ± 1.0          | 1832              | 20081186             |
| 3 x 70/35                  | FV             | 30.5 ± 1.5        | 2527              | 20109650             |
| 4 x 1.5/1.5                | ER             | 15 ± 0.8          | 314               | 20098053             |
| 4 x 2.5/2.5                | ER             | 16 ± 0.8          | 378               | 20098050             |
| 4 x 4/4                    | FR             | 18 ± 0.8          | 510               | 20098062             |
| 4 x 6/6                    | FR             | 19 ± 0.8          | 650               | 20098056             |
| 4 x 10/10                  | FR             | 22.5 ± 1.0        | 952               | 20098060             |
| 4 x 16/16                  | FR             | 25.5 ± 1.0        | 1343              | 20098061             |
| 4 x 25/16                  | FR             | 30.5 ± 1.5        | 1949              | 20077212             |
| 4 x 35/16                  | FV             | 30.5 ± 1.5        | 1780              |                      |
| 4 x 50/25                  | FV             | 30.5 ± 1.5        | 2316              |                      |
| 4 x 70/35                  | FV             | 34 ± 1.5          | 3218              | 20108742             |
| 4 x 95/50                  | FV             | 39.5 ± 1.5        | 4382              | 20108743             |
| 4 x 150/70                 | FV             | 47 ± 2.0          | 6673              | 20108744             |

# 1. Electrification of main lines

## RAILWAY NETWORK SYSTEM

### IFSI EMC PURE 0.6/1 kV

#### EMC RESISTANT & FLAME RETARDANT

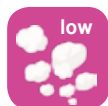

#### Application

Halogen free power cable for indoor and outdoor grounding without additional protection. The copper screen is 100% dense with low coupling impedance that fulfills the EMC directive. 3-wire cable is symmetrically built.

#### Technical data

##### Rated voltage:

- > 0.6/1 kV

##### Test voltage:

- > 4,000 V

##### Bending radius:

- > During installation: 12 x D
- > Fixed: 8 x D

#### Temperature range

- > Max. conductor temperature: +90°C
- > Short circuit temperature: +250°C
- > Lowest temp. at installation: -20°C
- > Below 0°C exercise caution

#### Standard & Directive & Approval

##### Standard:

- > Cenelec HD 604-5D, IEC 60502-1
- > Cenelec N1ZC7Z1-AR, N1ZA5Z1-AS

##### Directive:

- > Fulfills RoHS & REACH

##### Approval:

- > CPR class: Dca-s2d2a2

#### Construction

##### Conductor:

- > Round
- > Stranded aluminium
- > Acc. to IEC 60228 class 2.

##### Insulation:

- > XLPE

##### Core colouring:

- > 3-core: brown, black, grey
- > 4-core: brown, black, grey, blue

##### Filler /Wrapping:

- > Halogen free tape or compound

##### Screen:

- > Copper foil with overlap
- > Helix of copper wires
- > 100% coverage
- > Fulfills EMC-directive

##### Outer sheath:

- > Halogen free polymer
- > Black

#### Material property

- > Flame retardant: IEC 60332-1
- > Halogen free: IEC 60754-1
- > Acidity: IEC 60754-2
- > Smoke density: IEC 61034

Content is subject to changes acc. to current product development and or any changes to standards.

| Conductor cross-section mm <sup>2</sup> | Conductor type | Outer diameter mm | Weight kg/km | Standard delivery m | Prysmian EAN no. |
|-----------------------------------------|----------------|-------------------|--------------|---------------------|------------------|
| 3 x 25/10                               | AFR            | 21.5 ± 1.0        | 550          | 4,320               | 7330384720540    |
| 3 x 50/16                               | AFV            | 23 ± 1.0          | 855          | 6,200               | 7330384720557    |
| 3 x 95/35                               | AFV            | 31 ± 1.5          | 1530         | 9,350               | 7330384720564    |
| 3 x 150/50                              | AFV            | 37.5 ± 1.5        | 2225         | 13,770              | 7330384720571    |
| 3 x 240/70                              | AFV            | 45.5 ± 2.0        | 3,455        | 20,780              | 7330384720588    |
| 4 x 25/10                               | AFR            | 23 ± 1.0          | 670          | 5,960               | 7330384720595    |
| 4 x 50/16                               | AFV            | 27 ± 1.0          | 1,020        | 7,830               | 7330384720601    |
| 4 x 95/35                               | AFV            | 37.5 ± 1.5        | 1,880        | 11,880              | 7330384720618    |
| 4 x 150/50                              | AFV            | 42 ± 2.0          | 2,705        | 17,470              | 7330384720625    |
| 4 x 240/70                              | AFV            | 51.5 ± 2.5        | 4,270        | 26,430              | 7330384720632    |

## GROUNDING

### HK

#### STRANDED ANNEALED COPPER CONDUCTOR

##### Application

Annealed copper conductor for grounding of metal parts for different railway network systems.

##### Technical data

###### Bending radius:

- > During installation: 15 x D
- > Fixed: 10 x D

###### Pulling force:

- > Using grip or eye: max. 50 N/mm<sup>2</sup>

##### Standard

###### Standard:

- > IEC 60288

###### Directive:

- > Fulfills RoHS

##### Construction

###### Conductor:

- > Round
- > Solid copper wires
- > Annealed
- > Stranded
- > Acc. to IEC 60228 class 2.



Content is subject to changes acc. to current product development and or any changes to standards.

| Conductor cross-section mm <sup>2</sup> | Number of wires | Outer diameter mm | Weight kg/km | Standard length m | Prysmian EAN no. |
|-----------------------------------------|-----------------|-------------------|--------------|-------------------|------------------|
| 50                                      | 19              | 8.9               | 430          | 1000 - K7         | 6410001053501    |
| 70                                      | 19              | 11                | 610          | 1000 - K9         | 6410001053709    |
| 95                                      | 19              | 13                | 850          | 1000 - K11        | 6410001053952    |
| 120                                     | 37              | 15                | 1,100        | 500 - K11         | 6410001053976    |
| 150                                     | 37              | 16                | 1,312        | 500 - K11         | 6410001050142    |



# 1. Electrification of main lines

## GROUNDING

### KGF

#### STRANDED ANNEALED COPPER CONDUCTOR



##### Application

Annealed copper conductor for grounding of metal parts of different railway network systems.

##### Technical data

###### Resistance:

- > Max. 17.24  $\Omega$ /km

###### Pulling force:

- > 240 N/mm<sup>2</sup>

###### Elongation:

- > 20-30%

###### Bending radius:

- > During installation 15 x D
- > Fixed 10 x D

##### Standard

- > IEC 60288
- > HD 383

##### Construction

###### Conductor:

- > Round
- > Solid copper wires
- > Annealed
- > Stranded
- > Acc. to IEC 60228 class 2.

Content is subject to changes acc. to current product development and or any changes to standards.

| Conductor cross-section mm <sup>2</sup> | No. wires x diameter | Outer diameter mm | Weight kg/km | Standard length m | Prysmian EAN no. |
|-----------------------------------------|----------------------|-------------------|--------------|-------------------|------------------|
| 50                                      | 7 x 2.88             | 9.0               | 41.2         | 1000              | 7021521309581    |
| 70                                      | 19 x 2.12            | 11.0              | 60.4         | 1000              | 7021521309604    |
| 95                                      | 19 x 2.50            | 12.6              | 85.0         | 1000              | 7021521309703    |
| 120                                     | 37 x 2.01            | 14.2              | 107.0        | 500               | 7021521309758    |
| 150                                     | 37 x 2.28            | 15.9              | 131.2        | 500               | 7021521309772    |

## GROUNDING

### KHF

#### STRANDED HARD DRAWN COPPER CONDUCTOR

##### Application

Solid hard drawn copper conductor for grounding of metal parts of different railway network systems.

##### Technical data

###### Resistance:

- > Max. 17.77  $\Omega$ /km

###### Pulling force:

- > 350-450 N/mm<sup>2</sup>

###### Elongation:

- > At 90% load: 0,5%

##### Standard

- > IEC 60288
- > HD 383

##### Construction

###### Conductor:

- > Round
- > Solid copper wires
- > Hard drawn
- > Stranded
- > Acc. to IEC 60228 class 2.



Content is subject to changes acc. to current product development and or any changes to standards.

| Conductor cross-section mm <sup>2</sup> | No. wires x diameter | Outer diameter mm | Weight kg/km | Standard length m | Prysmian EAN no. |
|-----------------------------------------|----------------------|-------------------|--------------|-------------------|------------------|
| 25                                      | 7 x 2.10             | 6.5 ± 0,5         | 214          | 2000              |                  |
| 35                                      | 7 x 2.50             | 7.5 ± 0,5         | 304          | 1500              |                  |
| 50                                      | 7 x 2.88             | 8.5 ± 0,5         | 412          | 500               |                  |
| 50                                      | 7 x 2.88             | 8.5 ± 0,5         | 412          | 1000              |                  |
| 70                                      | 19 x 2.12            | 10.5 ± 0,5        | 604          | 750               |                  |
| 95                                      |                      |                   |              |                   |                  |
| 150                                     |                      |                   |              |                   |                  |

# 1. Electrification of main lines

## GROUNDING

### IX PURE 450/750 V

#### INSULATED & HALOGEN FREE COPPER WIRE



#### Application

Halogen free and flame retardant wire for grounding of metal parts of different railway network systems.

#### Technical data

Rated voltage:

- > 450/750 V

Test voltage:

- > 2,500 V

Bending radius:

- > 6 x D

#### Temperature range

- > Max. conductor temperature: +70°C
- > Short circuit temperature: +160°C
- > Lowest temp. at installation: -20°C
- > Below 0°C exercise caution

#### Standard & Directive & Approval

Standard:

- > EN 50525-3-31

Directive:

- > Fulfills RoHS & REACH

Approval:

- > CPR class: Cca-s1d1a1

#### Construction

Conductor:

- > Round
- > Stranded copper wires
- > Acc. to IEC 60228 class 2.

Insulation:

- > Halogen free polymer
- > Yellow/green

#### Material property

- > Flame retardant: IEC 60332-1
- > Halogen free: IEC 60754-1

Content is subject to changes acc. to current product development and or any changes to standards.

| Conductor cross-section mm <sup>2</sup> | Outer diameter mm | Weight kg/km | Standard length m | Prysmian EAN no. |
|-----------------------------------------|-------------------|--------------|-------------------|------------------|
| 1 G 50                                  | 11.5              | 492          | 500               | 6410004062401    |
| 1 G 70                                  | 13.0              | 681          | 500               | 641000406456     |
| 1 G 95                                  | 15.5              | 932          | 500               | 6410004062470    |
| 1 G 150                                 |                   | 10311        | 500               | 6410004062517    |

## GROUNDING

# PN 450/750 V

## INSULATED & FLAME RETARDANT COPPER WIRE

### Application

Flame retardant wire for grounding of metal parts of different railway network systems.

### Technical data

Rated voltage:

- > 450/750 V

Test voltage:

- > 2,500 V

Bending radius:

- > 6 x D

### Temperature range

- > Max. conductor temperature: +70°C
- > Short circuit temperature: +160°C
- > Lowest temp. at installation: -10°C

### Standard & Directive & Approval

Standard:

- > EN 50525-2-31
- > IEC 60227-3

Directive:

- > Fulfills RoHS & REACH

Approval:

- > CPR class: Cca-s1d1a1

### Construction

Conductor:

- > Round
- > Stranded copper wire
- > Acc. to IEC 60228 class 2.

Insulation:

- > PVC
- > Yellow/green

### Material property

- > Flame retardant: IEC 60332-1



70°



Content is subject to changes acc. to current product development and or any changes to standards.

| Conductor cross-section mm <sup>2</sup> | Outer diameter mm | Weight kg/km | Standard length m | Prysmian EAN no. |
|-----------------------------------------|-------------------|--------------|-------------------|------------------|
| 1 G 50                                  | 11.5              | 490          | 500               | 7021521736837    |
| 1 G 70                                  | 13.0              | 678          | 500               | 7021521739159    |
| 1 G 95                                  | 15.5              | 928          | 500               | 7021521740100    |
| 1 G 120                                 | 17.5              | 1,181        | 300               | 7021521745082    |
| 1 G 150                                 | 19.2              | 1,473        | 300               |                  |



# 1. Electrification of main lines

## GROUNDING

### RQ PURE 450/750 V

#### INSULATED & FLAME RETARDANT COPPER WIRE



#### Application

Flame retardant and halogen free multi-stranded wire for grounding of metal parts from different systems of railway networks.

#### Technical data

Rated voltage:

- > 450/750 V

Test voltage:

- > 2,500 V

Bending radius:

- > During installation: 8 x D
- > Fixed: 4 x D

#### Temperature range

- > Max. conductor temperature: +70°C
- > Lowest temp. at installation: -20°C

#### Standard & Directive & Approval

Standard:

- > EN 50525-3-31

Directive:

- > Fulfills RoHS & REACH

Approval:

- > CPR class: Dca-s2d2a2

#### Construction

Conductor:

- > Round
- > Copper wires
- > Multi-stranded
- > Acc. to IEC 60228 class 5.

Insulation:

- > Halogen free polymer
- > Black

#### Material property

- > Flame retardant: IEC 60332-1
- > Halogen free: IEC 60754-1
- > Acidity: IEC 60754-2
- > Smoke density: IEC 61034

Content is subject to changes acc. to current product development and or any changes to standards.

| Conductor cross-section mm <sup>2</sup> | Outer diameter mm | Weight kg/km | Standard length m | Prysmian EAN no. |
|-----------------------------------------|-------------------|--------------|-------------------|------------------|
| 1 G 50                                  | 11.5 ± 0.5        | 488          | 500               | 8430220304220    |
| 1 G 70                                  | 13 ± 0.5          | 644          | 500               | 8430220730876    |
| 1 G 95                                  | 15.5 ± 0.5        | 895          | 500               | 8430220219012    |
| 1 G 150                                 | 20 ± 0.5          | 1408         | 500               | 8430220501971    |



## ACCESSORY

# FORMFIT MULTI-CONNECTOR

## 12-36 kV SEPARABLE WITH TEST POINT



### Application

Watertight separable connector suitable for connecting polymer up to 36 kV cables to transformers, switchgear units, motors etc. Available as a straight FMCS-400, elbow FMCE-400 or tee FMCT-400 connector. For indoor and outdoor application of:

- > Single core cables
- > PE, XLPE and ERP insulation
- > CU or AL conductor
- > Semi-conducting screen
- > Screen of metal, wire or tape
- > Insulation voltage up to 36 kV
- > From 25-240 (300) mm<sup>2</sup>
- > For continuous 400 A rms
- > Overload 600 A rms
- > Interface B

### Installation features

- > No need for special tools
- > No need for heating, taping or filling
- > Vertical, angled or inverted position
- > No min. distance between phases
- > Immediate energizing possible
- > Individual clamping by steel brace

### Construction

- > Contact pin assembly
- > Semi-conducting inner screen
- > Semi-conducting outer jacket
- > Insulating body of moulded EPDM
- > Test point electrically protected by cap
- > Adapter of EPDM moulding
- > Locking brace of stainless steel
- > Earthing cover of moulded EPDM
- > Earthing eye

### Standard

- > VDE 0278-C 33-051, CC 33-001
- > HD 629-1 og IEC 60502-4
- > Cenelec EN 50180, EN 50181

### Delivery

- > Supplied as a kit of 3 single connectors containing all components.

Content is subject to changes acc. to current product development and or any changes to standards.

| Diameter over insulation |      | Kit reference | Conductor size in mm (for guidance only) |       |       |       |
|--------------------------|------|---------------|------------------------------------------|-------|-------|-------|
| Min.                     | Max. |               | 12 kV                                    | 17 kV | 24 kV | 36 kV |
| 18.5                     | 20.5 | FMCE-400-Z    | 70                                       | 50    | 35    |       |
| 19.9                     | 21.9 | FMCE-400-A    | 95                                       | 70    | 50    |       |
| 21.4                     | 23.5 | FMCE-400-B    | 120                                      | 95    | 70    | 25    |
| 22.9                     | 25.1 | FMCE-400-C    | 150                                      | 120   | 95    | 35    |
| 24.4                     | 26.6 | FMCE-400-D    | 185                                      | 150   | 120   | 50    |
| 26.0                     | 28.3 | FMCE-400-E    | 240                                      | 185   | 150   | 70    |
| 27.8                     | 30.4 | FMCE-400-F    | 300                                      | 240   | 185   | 95    |
| 29.8                     | 32.7 | FMCE-400-G    |                                          | 300   | 240   | 120   |
| 31.8                     | 35.3 | FMCE-400-H    |                                          |       | 300   | 185   |
| 34.1                     | 38.3 | FMCE-400-J    |                                          |       |       | 240   |



## ACCESSORY

# ELASCON TEE CONNECTOR

## 12-36 kV SEPARABLE WITH MECHANICAL CONTACT

### Application

Watertight connector type MSCT/EC-630-C suitable for connecting polymer MV cables to transformers, switchgear units, motors etc. For indoor and outdoor application of:

- > Single core cables
- > PE, XLPE and ERP insulation
- > CU or AL conductor solid or stranded
- > Semi-conducting screen
- > Screen of metal, wire or tape
- > Insulation voltage up to 18/30 (36) kV
- > Conductor size: 25 - 300 mm<sup>2</sup>
- > For continuous 630 A rms
- > Overload 900 A rms

### Installation features

- > No need for special tools
- > No need for heating, taping or filling
- > Vertical, angled or inverted position
- > No min. distance between phases
- > Immediate energizing possible

### Standard

- > HD 629.1 S2
- > IEC 60502-4 NF C 33-051 - NF C 33-001
- > IEC 61238-1 class A - mechanical contact

### Construction

- > Section mechanical conductor contact
- > M16 clamping screw
- > Semi-conducting inner screen
- > Semi-conducting outer envelope
- > Insulating body mould EPDM
- > Test point electrically protected by cap
- > Insulating plug epoxy component
- > Cap of moulded semi-conducting EPDM
- > Earthing eye
- > Moulded high permittivity reducer

### Standard

- > Cenelec HD 629.1 S2
- > IEC 60502-4 - NF C33-051 - NF C 33-001.
- > Cenelec EN 50180, EN 50181
- > IEC 61238-1 class A, HN 68-S-91

### Versions available

- > Elascron is available in versoin for 250, 400 and 630 continuous A rms.

### Delivery

- > Supplied as a kit of 3 single connectors containing all components.



Content is subject to changes acc. to current product development and or any changes to standards.

| Voltage kV | Diameter over insulation |      | Conductor size in mm <sup>2</sup> (for guidance only) |     | Prysmian order no.           |
|------------|--------------------------|------|-------------------------------------------------------|-----|------------------------------|
|            | Min.                     | Max. |                                                       |     |                              |
| 12         | 13.0                     | 22.3 | 25                                                    | 120 | MSCEA/EC-630-C-12-rA-25/120  |
| 12         | 16.1                     | 26.3 | 95                                                    | 240 | MSCEA/EC-630-C-12-rB-95/240  |
| 12         | 22.7                     | 33.0 | 185                                                   | 300 | MSCEA/EC-630-C-12-rC-185/300 |
| 17         | 13.0                     | 22.3 | 70                                                    | 70  | MSCEA/EC-630-C-17-rA-25/70   |
| 17         | 16.1                     | 26.3 | 120                                                   | 120 | MSCEA/EC-630-C-17-rB-35/120  |
| 17         | 20.2                     | 30.8 | 240                                                   | 240 | MSCEA/EC-630-C-17-rC-95/240  |
| 17         | 25.6                     | 35.3 | 300                                                   | 300 | MSCEA/EC-630-C-17-rE-185/300 |
| 24         | 16.1                     | 26.3 | 185                                                   | 150 | MSCEA/EC-630-C-24-rB-25/150  |
| 24         | 16.1                     | 26.3 | 185                                                   | 195 | MSCEA/EC-630-C-24-rB-70/185  |
| 24         | 20.2                     | 30.8 | 240                                                   | 240 | MSCEA/EC-630-C-24-rC-95/240  |
| 24         | 22.7                     | 33.0 | 240                                                   | 240 | MSCEA/EC-630-C-24-rD-95/240  |
| 24         | 25.6                     | 35.3 | 300                                                   | 300 | MSCEA/EC-630-C-24-rE-185/300 |
| 36         | 20.2                     | 30.8 | 95                                                    | 95  | MSCEA/EC-630-C-36-rC-25/95   |
| 36         | 22.7                     | 33.1 | 120                                                   | 120 | MSCEA/EC-630-C-36-rD-35/120  |
| 36         | 25.6                     | 35.3 | 240                                                   | 240 | MSCEA/EC-630-C-36-rE-70/240  |
| 36         | 30.5                     | 40.6 | 150                                                   | 300 | MSCEA/EC-630-C-36-rF-150/300 |



## ACCESSORY

# SIXTY-SPEED JOINT 72.5 kV

## ALL-IN-ONE FACTORY TESTED COLD SHRINK EPR



### Description

- > Factory pre-assembled
- > Factory pre-tested
- > Cold-shrink EPR joint
- > All-in-one design
- > Integrated link-devices
- > Integrated elastic outer sheath
- > Sectionalized version
- > Non-sectionalized version
- > Self-ejecting technology
- > Shear bolts mechanical connector
- > Tool free solution
- > LEAN product - few components

### Application

- > Joint for single-core extruded cables (XLPE or EPR)
- > Copper or aluminium conductor
- > Copper wire screen or aluminium laminated sheath
- > Cable sizes from 120 mm<sup>2</sup> (240 kcmil) up to 1000 mm<sup>2</sup> (2000 kcmil)
- > Voltage: 36/69 (72.5 kV) (IEC)
- > Voltage: 39.8/69 kV (BIL 350 kV crest) (IEEE)
- > Suitable for buried installations also in presence of water table (1 m water-proof)

### Installation features

- > Easy to install: No special tools are required (tool-free solution).
- > Quick assembling: Designed for reducing installation time. Main components are already expanded and placed in the correct position. Joint sealing simply done by removing supports from the outer sheath.
- > Self-ejecting supports: No special skill required for the installation.
- > 100% factory tested: Submitted to electrical test and partial discharges measurements before shipping.
- > 2 years shelf-life.

### Additional options

- > Metallic casing as additional mechanical protection.
- > Coffin-box filled with resin as additional water protection suitable for concentric cross-bonding cable.
- > Heat-shrinkable outer protection instead of the integrated elastic outer sheath.

### Qualification

- > Qualified in accordance to IEC 60840 and IEEE-404.
- > Short circuit tested (up to 40 kA/0.5 sec.)

Content is subject to changes acc. to current product development and or any changes to standards.

| Product references | Rated voltage kV | Sixty-Speed model | Cross-section range mm <sup>2</sup> | Insulation range mm | Max. outer diameter mm |
|--------------------|------------------|-------------------|-------------------------------------|---------------------|------------------------|
| CSJ(-X) 1072       | 72.5 kV          | 1                 | 120 - 240                           | 39.0 - 53.0         | 77.0                   |
| CSJ(-X) 1072       | 72.5 kV          | 2                 | 300 - 1000                          | 52.0 - 71.0         | 89.0                   |

## ACCESSORY

# COLDFIT TERMINATION 72.5 kV

## FACTORY EXPANDED WITH MODULAR DESIGN

### Application

Factory-expanded cold shrink silicone termination designed with factory-assembled moisture sealing components. Modular design allows for different creepage distances. Suitable for outdoor installation subject to severe climatic conditions. Installation without use of special tools.

- > Single core extruded cables (XLPE or EPR)
- > With CU or AL conductor
- > With wire screen or aminated sheath
- > Conductor size from 150-1,200 mm<sup>2</sup>

### Technical data

- > Rated voltage: 36/69 (72.5) kV
- > Terminal body creepage: 2,100 mm
- > Modular creepage: 600 mm
- > Total creepage distance: 2,700 mm
- > Acc. to IEC 60815

### Installation features

- > Easy to install - not tools needed
- > Quick assemble - LEAN few items
- > Extractable support - on plastic carrier
- > Vertical or angled position
- > Shear bolts mechanical connector
- > Excellent anti-tracking and hydrophobic
- > 100% factory tested
- > 2 year shelf-life

### Construction

#### Insulation body:

- > Cold shrink element
- > Silicone rubber
- > Expanded into a spiral support

#### Stress cone:

- > Designed to ensure voltage control
- > Suitable for all cables
- > Semi-conducting silicone rubber

#### Sealing tube:

- > Upper and lower (conductor/earth)
- > Cold shrink silicone rubber
- > Expanded into a spiral support

#### Tape:

- > High permittivity tape
- > Sealing mastic and silicone tape
- > Ensures watertightness

#### Conductor lug:

- > Suitable for copper or aluminium

### Standard

- > IEC 60840 / IEEE 404



Content is subject to changes acc. to current product development and or any changes to standards.

| Rated voltage kV | Model type | Cross section mm <sup>2</sup> | Insulation thickness mm | Outer diameter mm | A mm | B mm | C mm | D mm  | F creepage m |
|------------------|------------|-------------------------------|-------------------------|-------------------|------|------|------|-------|--------------|
| 72.5 kV          | 1          | 150 - 500                     | 33.5 - 48.8             | 57.0              | 750  | 146  | 186  | 1,000 | > 2.25       |
| 72.5 kV          | 2          | 500 - 1,200                   | 42.8 - 66.0             | 74.0              | 750  | 156  | 196  | 1,000 | > 2.25       |

## ACCESSORY

# ECOSPEED JOINT 24-36 kV

## STRAIGHT THROUGH JOINT, COLD SHRINK



### Application

Suitable for jointing of polymeric insulated cables of different specifications, for example as transition joint between extruded and paper insulated cables. Joint can be laid underground in tunnels, on horizontal racks or directly buried.

### Cable types

- > Single core polymeric insulation
- > Insulation voltage up to 36 kV (Um)
- > Copper or aluminium conductor
- > Conductor sizes 50 to 630 mm<sup>2</sup>
- > Tape, wire or polylam metallic screen
- > Non-armoured
- > Semi-conducting screen

### Selection guide

Select in the table below, the kit model corresponding to the insulation voltage Um (up to 24 kV or 36 kV), the diameter over insulation and over outer sheath.

Specify insulation voltage Um for 24 or 36 kV.

Select the screen continuity device according to the type of metallic screen of cable. T1 for polylam screen, T2 for tape screen and T3 for wire screen.

### Construction

- > Three layers sleeve
- > Two layers sheath
- > Copper mesh
- > High permittivity tape
- > PVC tape
- > Sealing mastic tape
- > Embossed copper tape
- > PVC strip
- > Identification label

### Standard

- > Fulfills IEC 60502-4
- > Fulfills CENELEC HD 629-1-2

### Installation characteristics

- > All-in-one compact design
- > Factory expanded onto a support
- > No special skills or experience required
- > Easy assembling
- > No special tools or heating needed
- > Wide cables size range
- > Immediate energizing after jointing
- > Great flexibility
- > Suitable for compact insulated cables

Content is subject to changes acc. to current product development and or any changes to standards.

| Rated voltage kV | Elaspeed model    | Min. outer insulation diameter mm | Max. outer sheath diameter incl. screen mm | Conductor size range (for guidance only) |
|------------------|-------------------|-----------------------------------|--------------------------------------------|------------------------------------------|
| 24 kV            | Ecospeed 151556   | 19                                | 40                                         | 50 - 240                                 |
| 24 kV            | Ecospeed 162662   | 24                                | 44                                         | 95 - 240                                 |
| 36 kV            | Ecospeed 151656-0 | 23                                | 40                                         | 50 - 120                                 |
| 36 kV            | Ecospeed 202070-1 | 28                                | 55                                         | 95 - 240                                 |
| 36 kV            | Ecospeed 202070-3 | 34                                | 55                                         | 300 - 630                                |
| 36 kV            | Ecospeed 252580-4 | 36                                | 62                                         | 500 - 630                                |

## ACCESSORY

# ELASPEED JOINT 12-36 kV

## STRAIGHT THROUGH JOINT, ELASTIC

### Application

For jointing of 1- or 3 core polymeric insulated cables of different specifications, conductor sizes, round or sector shaped. Joint has injected outer protection and integrated electrode. Suitable for jointing cables laid underground, in tunnels, on horizontal racks or aerial. Can be directly buried (after curing of resin). Supplied as a kit containing all the necessary components except the ferrules (supplied on request).

Elaspeed™ utilize cold shrink technology which doesn't require any special tools or torches for installation. The EPR rubber insulation is manufactured on a vertical extruder to ensure complete concentricity to the tightest tolerance possible.

### Cable types

- > 1- or 3-core polymeric insulation
- > Copper or aluminium conductor
- > Metallic screen of tape or wire
- > Semi-conducting screen (extruded/taped)
- > Insulation voltage up to 36 kV (Um)
- > Conductor sizes from 25-500 mm<sup>2</sup>
- > Non-armoured or armoured.

### Construction

- > Conductor ferrule, crimped
- > Joint body, extruded EPR
- > Removable carrier, pre-loaded
- > Core screen, copper
- > Outer protection, watertight

### Installation features

- > No need for special tools or heating.
- > Injection of resin with disposable injection device can be supplied directly in the kit - in this case, letter "F" to be added at the end of kit reference.
- > Energizing of cable 30 minutes after injecting.
- > Polymerisation of synthetic resins at ambient temp. +5°C to +45°C

### Standard

- > C 33 001 - DIN 57 278
- > IEEE 404 - IEC 60502-4
- > ENEL DJ 4853 - C 33 050-AI
- > CENELEC HD 629-1



Content is subject to changes acc. to current product development and or any changes to standards.

| Rated voltage kV | 1 core cable      |                                     |                    | 3 core cable      |                                     |                    |
|------------------|-------------------|-------------------------------------|--------------------|-------------------|-------------------------------------|--------------------|
|                  | Max. OD sheath mm | Max. conductor size mm <sup>2</sup> | Kit reference name | Max. OD sheath mm | Max. conductor size mm <sup>2</sup> | Kit reference name |
| 12               | 38                | 95 - 150                            | EPJM - 1C-12 E     | 19.0              | 95 - 150                            | RTMJ - 3C-12 E     |
| 12               | 49                | 195 - 300                           | EPJM - 1C-12 F     | 23.1              | 185 - 300                           | RTMJ - 3C-12 F     |
| 12               | 50                | 240 - 400                           | EPJM - 1C-12 H     | 24.4              | 240 - 400                           | RTMJ - 3C-12 H     |
| 12               | 57                | 300 - 500                           | EPJM - 1C-12 IP    | 27.8              | 300 - 500                           | RTMJ - 3C-12 IP    |
| 17.5             | 34                | 70 - 120                            | EPJM - 1C-17 E     | 19.0              | 70 - 120                            | RTMJ - 3C-17 E     |
| 17.5             | 44                | 150 - 240                           | EPJM - 1C-17 F     | 23.1              | 150 - 240                           | RTMJ - 3C-17 F     |
| 17.5             | 46                | 195 - 300                           | EPJM - 1C-17 H     | 24.4              | 185 - 300                           | RTMJ - 3C-17 H     |
| 17.5             | 52                | 240 - 500                           | EPJM - 1C-17 IP    | 27.8              | 240 - 500                           | RTMJ - 3C-17 IP    |
| 24               | 39                | 50 - 95                             | EPJM - 1C-24 E     | 19.0              | 50 - 95                             | RTMJ - 3C-24 E     |
| 24               | 48                | 95 - 240                            | EPJM - 1C-24 F     | 23.1              | 95 - 240                            | RTMJ - 3C-24 F     |
| 24               | 50                | 120 - 300                           | EPJM - 1C-24 H     | 24.4              | 120 - 300                           | RTMJ - 3C-24 H     |
| 24               | 57                | 195 - 400                           | EPJM - 1C-24 IP    | 27.8              | 185 - 400                           | RTMJ - 3C-24 IP    |
| 36               | 50                | 50 - 150                            | EPJM - 1C-36 H     | 24.4              | 50 - 150                            | RTMJ - 3C-36 H     |
| 36               | 57                | 95 - 300                            | EPJM - 1C-36 IP    | 27.8              | 95 - 300                            | RTMJ - 3C-36 IP    |
| 36               | 67                | 195 - 630                           | EPJM - 1C-36 I     |                   |                                     |                    |





NSB Type 75 - Christian Niclas Nordmark



## CATENARY CONTACT WIRE

### TRL

### PURE COPPER CONDUCTOR

#### Application

Copper wire for power transmission to electric railway lines. Suitable as catenary wire for AC and DC systems.

#### Standard

- > EN 50149 type A

#### Construction

##### Conductor:

- > Single strand
- > Pure copper - ETP
- > Hard drawn
- > Grooved
- > Identification marks acc. to EN 50149

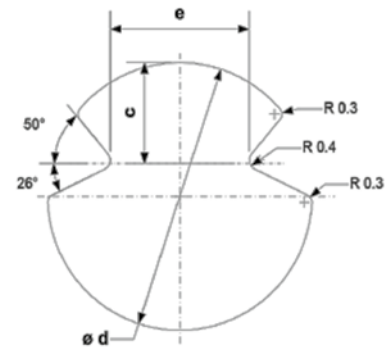
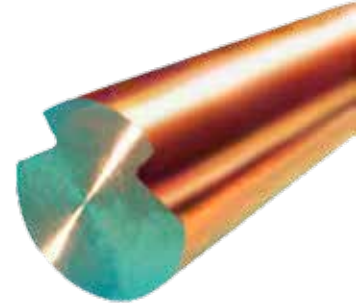

Content is subject to changes acc. to current product development and or any changes to standards.

| Conductor cross-section mm <sup>2</sup> | Conductor diameter mm | Weight kg/km | Standard length m | Prysmian order no. |
|-----------------------------------------|-----------------------|--------------|-------------------|--------------------|
| 80                                      | 10.6                  | 710          |                   | 0104008            |
| 100                                     | 12.0                  | 890          |                   | 0104010            |
| 120                                     | 13.2                  | 1067         |                   |                    |

| Conductor cross-section mm <sup>2</sup> | Rated tensile strength (RTS) kN | Coefficient of linear expansion /°C | Final modulus of elasticity GPa | Thermal oxide resistance kA |
|-----------------------------------------|---------------------------------|-------------------------------------|---------------------------------|-----------------------------|
| 80                                      | 28.4                            | 17 x 10 <sup>-6</sup>               | 120                             | 12                          |
| 100                                     | 35.5                            | 17 x 10 <sup>-6</sup>               | 120                             | 15                          |
| 120                                     | 42.0                            | 17 x 10 <sup>-6</sup>               | 120                             |                             |

## 2. Overhead catenary lines

### CATENARY CONTACT WIRE

## TRL CuAg

### COPPER-SILVER ALLOYED CONDUCTOR

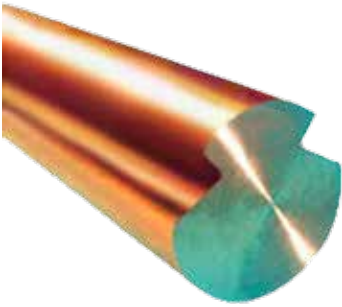

#### Application

Copper-silver alloyed wire for power transmission to electric railway lines. Suitable as catenary wire for AC and DC systems.

#### Standard

- > EN 50149

#### Construction

##### Conductor:

- > Singel strand
- > Silver alloyed copper
- > Grooved
- > Hard drawn
- > Identification marks acc. to EN 50149

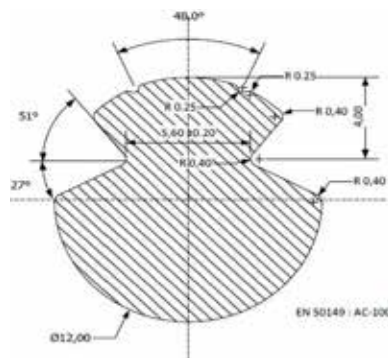
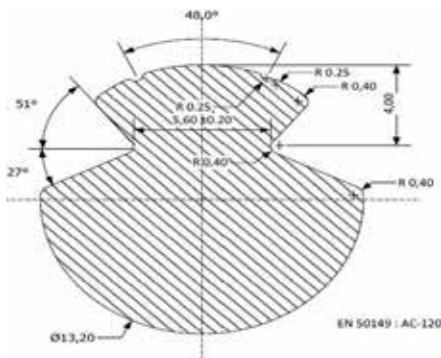

Content is subject to changes acc. to current product development and or any changes to standards.

| Conductor cross-section mm <sup>2</sup> | Outer diameter mm | Weight kg/km | Standard length m | Prysmian EAN no. |
|-----------------------------------------|-------------------|--------------|-------------------|------------------|
| 80                                      |                   |              |                   |                  |
| 100                                     | 12.0              | 980          |                   |                  |
| 120                                     | 13.2              | 1,067        |                   |                  |

| Conductor cross-section mm <sup>2</sup> | Rated tensile strength (RTS) kN | Coefficient of linear expansion /°C | Final modulus of elasticity GPa | DC resistance at 20°C Ω/km |
|-----------------------------------------|---------------------------------|-------------------------------------|---------------------------------|----------------------------|
| 80                                      |                                 |                                     |                                 |                            |
| 100                                     | 36.0                            | 17 x 10 <sup>-6</sup>               | 120                             | 0.183                      |
| 120                                     | 42.0                            | 17 x 10 <sup>-6</sup>               | 120                             | 0.153                      |

## CATENARY WIRE & DROPPER

### KK Bz-II 10 mm<sup>2</sup> or 50 mm<sup>2</sup>

#### STRANDED BRONZE ALLOYED COPPER CONDUCTOR

##### Application

Stranded bronze alloyed 1,35 or 3,0 mm copper wire concentrically stranded acc. to DIN 48201 part 2.

KK Bz-II 10 mm<sup>2</sup> suitable as dropper wire and KK Bz-II 50 mm<sup>2</sup> suitable as catenary wire in railway applications.

##### Construction

###### Conductor:

- > Round
- > Bronze alloyed copper wires
- > Hard drawn
- > Diameter nom: 1.35 or 3.0 mm
- > Stranded
- > Outer layer "Z" stranded

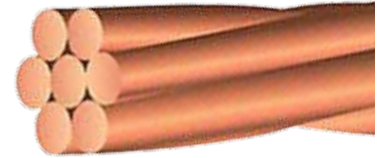

##### Technical data

###### Tensile strength:

- > Min. 618 N/mm<sup>2</sup>

###### Resistivity:

- > Max.: 27.78 n Ω m

##### Standard

- > DIN 48201 part 2.
- > DIN 48200 part 2. Bz-II

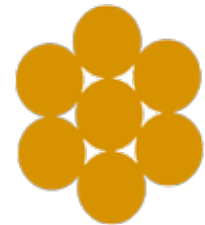

Content is subject to changes acc. to current product development and or any changes to standards.

| Conductor cross-section mm <sup>2</sup> | Outer diameter mm | Weight kg/km | Standard length m | Prysmian EAN no. |
|-----------------------------------------|-------------------|--------------|-------------------|------------------|
| 10 (7 x 1.35)                           | 4.1               | 90           |                   |                  |
| 50 (7 x 3.0)                            | 9.0               | 446          |                   |                  |

| Conductor cross-section mm <sup>2</sup> | Rated tensile strength (RTS) kN | Coefficient of linear expansion /°C | Final modulus of elasticity GPa | DC resistance at 20 °C Ω/km |
|-----------------------------------------|---------------------------------|-------------------------------------|---------------------------------|-----------------------------|
| 10 (7 x 1.35)                           | 5.88                            | 17 x 10 <sup>-6</sup>               | 113                             | 2.8                         |
| 50 (7 x 3.0)                            | 28.58                           | 17 x 10 <sup>-6</sup>               | 113                             | 0.569                       |

## 2. Overhead catenary lines

### DROPPER

## KKM Bz-II 10 mm<sup>2</sup>

### MULTI-STRANDED COPPER ALLOYED CONDUCTOR

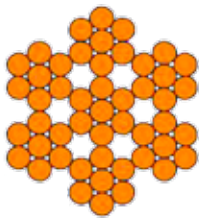
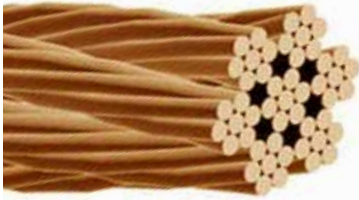

#### Application

Stranded bronze alloyed 0.5 mm copper wire concentrically bundled acc. to DIN 48201 part 2.

KKM Bz-II 10 mm<sup>2</sup> is suitable as dropper wire railway applications.

#### Technical data

##### Tensile strength:

- > Min. 618 N/mm<sup>2</sup>

##### Resistivity:

- > Max.: 27.78 n Ω m

#### Standard

- > DIN 48200 part 2.
- > DIN 43138.

#### Construction

##### Conductor:

- > Round
- > Multi-stranded
- > Bronze alloyed copper wires
- > Hard drawn
- > Diameter nom: 0.5 mm
- > Bunched sub-conductor: 7 x 0.5 mm
- > Outer layer "S" stranding

Content is subject to changes acc. to current product development and or any changes to standards.

| Conductor cross-section mm <sup>2</sup> | Outer diameter mm | Sub-conductor diameter nom. mm | Weight kg/km | Standard length m |
|-----------------------------------------|-------------------|--------------------------------|--------------|-------------------|
| 10 (7 x 7 x 0.5)                        | 4.5               | 7 x 0.05                       | 89           |                   |

| Conductor cross-section mm <sup>2</sup> | Rated tensile strength (RTS) kN | Outer layer stranded | DC resistance at 20°C Ω/km | Prysmian EAN no. |
|-----------------------------------------|---------------------------------|----------------------|----------------------------|------------------|
| 10 (7 x 7 x 0.5)                        | 589                             | Right handed         | 2.98                       |                  |

## RETURN WIRE

# AAC

## STRANDED ALUMINIUM CONDUCTOR

### Application

Cable for energy transmission designed with concentric layers. Suitable for fixed installation as return wire for railway application outdoors.

### Technical data

#### Bending radius:

- > During installation: min. 0.2 m
- > Fixed: min. 0.14 m

#### Conductor initial modulus:

- > 41,000 N/mm<sup>2</sup>

#### Resistor module:

- > 60,000 N/mm<sup>2</sup>

### Temperature range

- > Max. conductor temperature: +80°C
- > Short circuit temperature: +160°C

### Standard & Directive

#### Standard:

- > EN 50182
- > IEC 61089
- > SFS 5701

#### Directive:

- > Fulfills REACH and RoHS

### Construction

#### Conductor:

- > Round
- > Solid aluminium 4.42 mm
- > 7 wires
- > Stranded
- > Acc. to EN 50182
- > Outer layer "Z" stranding



**80°**

Content is subject to changes acc. to current product development and or any changes to standards.

| Conductor cross-section mm <sup>2</sup> | Number of wires | Outer diameter mm | Weight kg/km | Standard length m | Prysmian article no. |
|-----------------------------------------|-----------------|-------------------|--------------|-------------------|----------------------|
| 107                                     | 7               | 13,3              | 294          | 2100 - G13        | 0120250              |

| Conductor cross-section mm <sup>2</sup> | Rated tensile strength (RTS) kN | Coefficient of linear expansion /°C | Thermal oxide resistance kA | DC resistance at 20°C Ω/km |
|-----------------------------------------|---------------------------------|-------------------------------------|-----------------------------|----------------------------|
| 107                                     | 17.2                            | 23 x 10 <sup>-6</sup>               | 9.6                         | 0.267                      |



## 2. Overhead catenary lines

### RETURN WIRE

## ACSR

### STEEL REINFORCED ALU CONDUCTOR



#### Application

Cable for energy transmission designed with concentric layers of aluminium wires and inside of galvanized and fat enclosed steel wires. Suitable for outdoor fixed installation as return wire for railway applications.

#### Construction

##### Conductor:

- > Round
- > Outer wires of aluminium
- > Inner wires of steel
- > Stranded
- > Outer layer right handed "Z" stranded

#### Temperature range

- > Max. conductor temperature: +80°C
- > Short circuit temperature: +160°C

#### Standard

- > EN 50182
- > IEC 61089
- > SFS 5701

80°

Content is subject to changes acc. to current product development and or any changes to standards.

| Conductor cross-section mm <sup>2</sup> | Number of AL wires | Number of steel wires | Outer diameter mm | Weight kg/km | Standard length m | Prysmian EAN no. |
|-----------------------------------------|--------------------|-----------------------|-------------------|--------------|-------------------|------------------|
| 39.5 (34/6)                             | 6                  | 1                     | 8.04              | 137          | 2,500             | 6410001202022    |
| 671 (42/25)                             | 12                 | 7                     | 10.6              | 310          | 2,500             | 6410001202282    |
| 62.4 (54/9)                             | 6                  | 1                     | 10.1              | 216          | 2,200             | 6410001202053    |
| 99.3 (85/14)                            | 6                  | 1                     | 12.8              | 344          | 2,000             | 6410001202091    |
| 142 (89/52)                             | 6                  | 7                     | 15.4              | 654          | 2,500             | 6410001202132    |
| 177 (152/25)                            | 26                 | 7                     | 17.3              | 613          | 2,500             | 6410001202152    |
| 281 (242/39)                            | 26                 | 7                     | 21.3              | 976          | 2,500             | 6410001202183    |
| 344 (305/39)                            | 54                 | 7                     | 24.1              | 1,151        | 2,200             | 6410001202213    |
| 454.5 (402/52)                          | 54                 | 7                     | 27.7              | 1,520        | 2,300             | 6410001054072    |
| 637 (565/72)                            | 54                 | 19                    | 32.9              | 2,123        | 1,400             | 6410001202244    |

| Conductor cross-section mm <sup>2</sup> | 39.5                  | 671                   | 62.4                  | 99.3                  | 142                   | 177                   | 281                   | 344                   | 454.5                 | 637                   |
|-----------------------------------------|-----------------------|-----------------------|-----------------------|-----------------------|-----------------------|-----------------------|-----------------------|-----------------------|-----------------------|-----------------------|
| Rated tensile strength min. kN          | 12.2                  | 13.52                 | 1711                  | 24.13                 | 33.37                 | 54.8                  | 84.9                  | 96.8                  | 123.75                | 174                   |
| Coefficient of linear expansion /°C     | 19.2x10 <sup>-6</sup> | 15.6x10 <sup>-6</sup> | 19.2x10 <sup>-6</sup> | 19.2x10 <sup>-6</sup> | 15.6x10 <sup>-6</sup> | 19.2x10 <sup>-6</sup> | 19.2x10 <sup>-6</sup> | 19.3x10 <sup>-6</sup> | 19.3x10 <sup>-6</sup> | 19.3x10 <sup>-6</sup> |
| Final modulus of elasticity GPa         | 78                    | 102                   | 78                    | 78                    | 102                   | 76                    | 76                    | 67                    | 68                    | 63                    |
| DC resistance at 20°C Ω/km              | 0.848                 | 0.682                 | 0.536                 | 0.337                 | 0.323                 | 0.190                 | 0.120                 | 0.0949                | 0.0719                | 0.0512                |
| Short circuit current max kA            | 3.7                   | 5.4                   | 5.8                   | 9.2                   | 11.4                  | 16.5                  | 26.1                  | 32.5                  | 43.7                  | 60.1                  |

## RETURN WIRE

# IXXI 0.6/1 kV

## FLAME RETARDANT CONNECTION CABLE

### Application

Connection cable for installation outdoor and indoor. Halogen free cable is recommended when it is important to avoid heavy smoke and corrosive gases in case of fire.

### Technical data

#### Rated voltage:

- > 0,6/1 kV

#### Bending radius:

- > 5 x D

### Temperature range

- > Max. conductor temperature: +90°C
- > Short circuit temperature: +160°C

### Standard

- > IEC 60502-1
- > CENELEC HD 604 - materials

### Directive & Approval

#### Directive:

- > Fulfills RoHS & REACH-directives

#### Approval:

- > NEMCO

### Construction

#### Conductor:

- > Round
- > Stranded copper wires
- > Acc. to IEC 60228
- > 16-95 mm<sup>2</sup> - class 2.
- > 120-300 mm<sup>2</sup> - class 5.

#### Insulation:

- > Halogen free polymer
- > Black

#### Sheath:

- > Halogen free polymer
- > Black

### Material property

- > Flame retardant: IEC 60332-3C
- > Halogen free: IEC 60754-1 & 2
- > Acidity: IEC 60754-2
- > Smoke density: IEC 61034



Content is subject to changes acc. to current product development and or any changes to standards.

| Conductor cross-section mm <sup>2</sup> | Outer diameter mm | Weight kg/km | Standard length m | Prysmian EAN no. |
|-----------------------------------------|-------------------|--------------|-------------------|------------------|
| 1 x 16                                  | 10                | 230          |                   |                  |
| 1 x 25                                  | 12                | 340          |                   |                  |
| 1 x 35                                  | 13                | 440          |                   |                  |
| 1 x 50                                  | 15                | 590          |                   |                  |
| 1 x 70                                  | 17                | 810          |                   |                  |
| 1 x 95                                  | 19                | 1,090        |                   |                  |
| 1 x 120                                 | 23                | 1,330        |                   |                  |
| 1 x 150                                 | 25                | 1,660        |                   |                  |
| 1 x 185                                 | 28                | 2,020        |                   |                  |
| 1 x 240                                 | 32                | 2,680        |                   |                  |
| 1 x 300                                 | 35                | 3,250        |                   |                  |

## 2. Overhead catenary lines

### RETURN WIRE

## RZ1-K 0.6/1 kV

### FLEXIBLE & UV RESISTANT

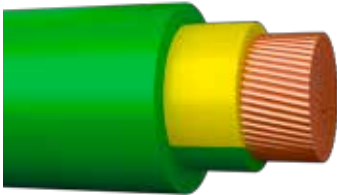

#### Application

Halogen free installation cable with high flexibility and low bending radius. Suitable for installation in factories and machines either in cable trays, ladders or for cabinet installation. The cable is UV-resistant and can be applied outdoors and indoors as well as directly in the ground.

#### Technical data

##### Rated voltage:

- > 0.6/1 kV

##### Test voltage:

- > 3,500 V

##### Bending radius:

- > Fixed < 25mm: 4 x D
- > During installation > 25mm: 5 x D
- > Ploughed down > 50mm: 6 x D

#### Temperature range

- > Max. conductor temperature: +90°C
- > Short circuit temperature: +250°C
- > Lowest tempe. at installation: -40°C

#### Standard & Directive & Approval

##### Standard:

- > Cenelec UNE 21123-4, IEC 60502-1

##### Directive:

- > Fulfills RoHS & REACH

##### Approval:

- > CPR class: Cca- s1bd1a1
- > DoP no.: 1000820

#### Construction

##### Conductor:

- > Round
- > Annealed copper wires
- > Multi-stranded and flexible
- > Acc. to IEC 60228 class 5.

##### Insulation:

- > XLPE
- > UV resistant

##### Core colouring:

- > 1-core: Green/yellow

##### Outer sheath:

- > Halogen free compound
- > Green

#### Material property

- > Flame retardant: IEC 60332-3-24 cat. 3
- > Halogen free: IEC 60754-1
- > Acidity: IEC 60754-2
- > Smoke density: IEC 61034
- > Current load: Acc. to SB 2001:6

Content is subject to changes acc. to current product development and or any changes to standards.

| Conductor cross-section mm <sup>2</sup> | Outer diameter mm | Weight kg/km | Standard length m | Prysmian EAN no. |
|-----------------------------------------|-------------------|--------------|-------------------|------------------|
| 1 G 240                                 | 274               | 2,350        | T500              | 8430220088083    |

Avgang

09:48 Oslo S / Lillestrøm

NSB Lokaltog - Stopper ved alle stasjoner

Spør  
Track

3





## BALISE

### L1-MEBI-45P

#### JELLY FILLED & ARMoured



#### Application

Signalling cable for railway application. Applicable for installation directly in the ground or in ducts. Also suitable for train detection ETCS.

#### Technical data

##### Design:

- > Pairs
- > a-core red
- > b-core black

##### Bending radius:

- > Admissible min:  $10 \times D$

##### Resistance:

- > Conductor:  $\leq 9.5 \Omega/\text{km}$
- > Insulation:  $\geq 1.0 G\Omega \times \text{km}$

##### Mutual capacitance at 800-1000 Hz:

- > Nom.  $45 \text{ nF}/\text{km}$ , Max  $\leq 55 \text{ nF}/\text{km}$

##### Capacitance unbalance:

- >  $k \leq 240 \text{ pF}/\text{km}$
- >  $e \leq 1300 \text{ pF}/\text{km}$

##### Dielectric strength:

- > At 50 Hz:  $1000 \text{ V rms}$

#### Temperature range

- > During installation:  $-10^\circ\text{C}$  to  $+50^\circ\text{C}$
- > In operations:  $-30^\circ\text{C}$  to  $+70^\circ\text{C}$

#### Material property

- > Flame retardant: IEC 60332-1
- > Halogen free: IEC 60754-1

#### Construction

##### Conductor:

- > Round
- > Copper wire
- > Softly annealed
- > Diameter  $2.0 \text{ mm}$

##### Insulation:

- > Foam-skin-PE

##### Twisting:

- > Two cores laid up in pairs
- > Pairs stranded in concentric layers

##### Filling:

- > Petro jelly with drop point  $\geq 80^\circ\text{C}$

##### Moisture barrier wrapping:

- > Swellable tape

##### Ripcord:

- > Two ripcords  $\geq 130 \text{ N}$  oppositely

##### Earth wire:

- > Stranded tinned copper
- > Cross-section  $1.5 \text{ mm}^2$

##### Armouring:

- > Two layer of galvanized steel tape
- >  $0.2 \text{ mm}$  helically applied with gap

##### Outer sheath:

- > PE material
- > Black

Content is subject to changes acc. to current product development and or any changes to standards.

| No. of pairs | Outer diameter mm | Weight kg/km | Standard length m | Drum size mm | Transport weight kg | Prysmian EAN no. |
|--------------|-------------------|--------------|-------------------|--------------|---------------------|------------------|
| 1            | 14                | 270          | 2000              | 1400         | 700                 |                  |

## BALISE

# A-2YTF(L)H(SR)H

## DRY CORE & ARMOURED

### Application

Low current signalling cable for outdoor railway application in ducts or directly buried. Halogen free and flame retardant.

### Technical data

#### Design:

- > 1 x 2 x 1.02 mm<sup>2</sup>
- > A-core white and b-core blue

#### Bending radius:

- > Admissible:  $\geq 10 \times D$

#### Resistance:

- > Conductor:  $\leq 21.5 \Omega/\text{km}$
- > Insulation:  $\geq 10 \text{ G}\Omega \times \text{km}$

#### Mutual capacitance at 800-1000 Hz:

- > Nom.  $44 \pm 2 \text{ nF}/\text{km}$
- > Max  $\leq 50 \text{ nF}/\text{km}$

#### Capacitance unbalance at 800 Hz:

- >  $k \leq 600 \text{ pF}/\text{km}$

#### Impedance at 1 MHz:

- >  $115 \pm 10 \Omega$

#### Test voltage at 50 Hz:

- > Core/core: 1500 V
- > Core/screen: 2500 V

### Temperature range

- > During installation:  $-15^\circ\text{C}$  to  $+40^\circ\text{C}$
- > In operations:  $-25^\circ\text{C}$  to  $+70^\circ\text{C}$

### Material property

- > Flame retardant: IEC 60332-1
- > Halogen free: IEC 60754-1

### Construction

#### Conductor:

- > Round
- > Solid copper wire
- > Softly annealed
- > Diameter 1.02 mm

#### Insulation:

- > PE (2Y)

#### Twisting:

- > Two cores laid up in pairs

#### Filling:

- > Water swellable material

#### Cable core wrapping:

- > Swellable tape overlapping

#### Drain wire:

- > Stranded tinned copper
- > 0,3 mm

#### Moisture barrier wrapping:

- > Laminate of aluminium tape
- > Coated with copolymer
- > Bonded to inner sheath

#### Inner sheath:

- > FRNC-PE
- > Flame retardant
- > Green

#### Armouring:

- > Corrugated steel tape, coated
- > Longitudinally applied with overlap

#### Outer sheath:

- > FRNC-PE
- > Halogen free
- > Flame retardant
- > Green

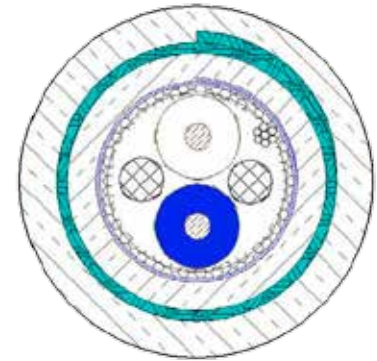

70°



Content is subject to changes acc. to current product development and or any changes to standards.

| No. of pairs | Outer diameter mm | Weight kg/km | Standard length m | Drum size mm | Transport weight kg | Prysmian EAN no. |
|--------------|-------------------|--------------|-------------------|--------------|---------------------|------------------|
| 1            | 14                | 220          | 1000              | 1200         | 310                 |                  |

## SIGNALLING

# FEBI 750 V ER/FR

## GEL FILLED & ARMoured

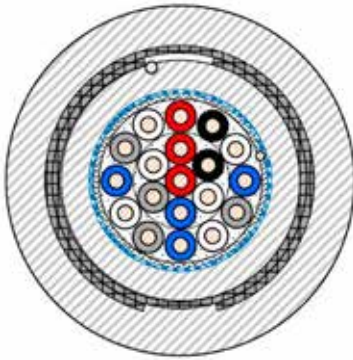

### Application

Flame retardant cable for railway signalling cables with PE sheath and insulation. Designed with gel filling and armoring. Suitable for installation directly in the ground or in ducts.

### Technical data

#### Bending radius:

- > Min. 10 x D

#### Temperature range:

- > During installation: - 10°C to + 50°C
- > In operations: - 30°C to + 70°C

#### Resistance:

- > Conductor:  $\leq 12.1$  or  $7.41 \Omega/\text{km}$
- > Insulation:  $\geq 1.0 \text{ G}\Omega \times \text{km}$

#### Mutual capacitance at 800-1000 Hz:

- > Two adjacent conductors:  $\leq 57 \text{ nF/km}$
- > One conductor and screen:  $\leq 80 \text{ nF/km}$
- > All conductors and screen:  $\leq 100 \text{ nF/km}$

#### Dielectric strength:

- > At 50 Hz: 12,000 V rms

### Material property

- > Flame retardant: IEC 60332-1
- > Halogen free: IEC 60754-1
- > Smoke density: IEC 61034

### Construction

#### Conductor:

- > Solid copper class 1. acc. to IEC 60228
- > Soft annealed 1.5 or 2.5 mm

#### Core colouring:

- > Red, black, white, blue, grey, white, blue, grey

#### Insulation:

- > Solid PE 0.8 mm acc. to EN 50290-2-23

#### Twisting:

- > Cores straned in concentric layers

#### Filling:

- > Interstices filled with filling compound
- > Drop point > 80°C

#### Moisture barrier:

- > One layer of swellable tape

#### Ripcord:

- > Ripcord

#### Earth wire:

- > Tinned copper conductor 0.5 mm

#### Inner sheath:

- > PE 1.2 mm, black

#### Earth wire:

- > Stranded tinned copper conductor 1.5 mm

#### Armouring:

- > Two layer of galvanized steel tape
- > 0.2 mm helically applied with gap

#### Outer sheath:

- > LSZH-FR material acc. to EN 50290-2-27
- > Black

Content is subject to changes acc. to current product development and or any changes to standards.

| Conductor cross-section mm <sup>2</sup> | Outer diameter mm | Weight kg/km | Conductor resistance max. $\Omega/\text{km}$ | Capacitance two adjacent cores nF/km | Prysmian article no. |
|-----------------------------------------|-------------------|--------------|----------------------------------------------|--------------------------------------|----------------------|
| 4 x 1.5                                 | 14 ± 0.8          | 297          | 12.1                                         | 57                                   | 20131922             |
| 7 x 1.5                                 | 16 ± 0.8          | 376          | 12.1                                         | 57                                   | 20131921             |
| 12 x 1.5                                | 20 ± 0.8          | 563          | 12.1                                         | 57                                   | 20153425             |
| 19 x 1.5                                | 22.5 ± 1.0        | 747          | 12.1                                         | 57                                   | 20131923             |
| 27 x 1.5                                | 26.5 ± 1.0        | 995          | 12.1                                         | 57                                   | 20131924             |
| 37 x 1.5                                | 29 ± 1.0          | 1248         | 12.1                                         | 57                                   | 20153426             |
| 48 x 1.5                                | 32.5 ± 1.5        | 1545         | 12.1                                         | 57                                   | 20153424             |
| 4 x 2.5                                 | 16.5 ± 0.8        | 400          | 7.41                                         | 80                                   | 20153445             |
| 7 x 2.5                                 | 19.5 ± 0.8        | 543          | 7.41                                         | 80                                   | 20153441             |
| 12 x 2.5                                | 24 ± 1.0          | 803          | 7.41                                         | 80                                   | 20131925             |
| 19 x 2.5                                | 27.5 ± 1.0        | 1111         | 7.41                                         | 80                                   | 20153447             |
| 27 x 2.5                                | 32 ± 1.5          | 1479         | 7.41                                         | 80                                   | 20153449             |
| 37 x 2.5                                | 35.5 ± 1.5        | 1889         | 7.41                                         | 80                                   | 20153451             |
| 48 x 2.5                                | 40 ± 2.0          | 2373         | 7.41                                         | 80                                   | 20153453             |

## SIGNALLING

# FTGS

## SCREENED & FLAME RETARDANT

### Application

Flame-retarded axle counter cable for analogous transmission of data. Can be installed directly into the ground or in ducts. Designed with a solid PE insulation and shielded with copper tape.

### Technical data

#### Design:

- > Quad cable
- > n x 4 x 0.9 or 1.4 mm

#### Bending radius:

- > Min. 10 x D

#### Resistance:

- > Conductor:  $\leq 0.9$  or  $1.7 \Omega/\text{km}$
- > Insulation:  $\geq 10 \text{ G}\Omega \times \text{km}$

#### Mutual capacitance at 800-1000 Hz:

- > For 0.9 mm<sup>2</sup>:  $38 \pm 3 \text{ nF/km}$  (max 45)
- > For 1.4 mm<sup>2</sup>:  $41 \pm 4 \text{ nF/km}$  (max 48)

#### Dielectric strength at 50 Hz:

- > core/core: 2,500 V rms
- > core/armouring: 2,500 V rms

### Temperature range:

- > During installation: -10°C to +50°C
- > In operations: -30°C to +70°C

### Material property

- > Flame retardant: IEC 60332-1
- > Halogen free: IEC 60754-1

### Construction

#### Conductor:

- > Solid copper wires
- > 0.9 or 1.4 mm
- > Softly annealed
- > Acc. to IEC 60228 class 1.

#### Core colouring example: 7x4x1.4 mm

- > 1-quad: orange, green, red, white
- > 2-quad: orange, green, red, black
- > 3-quad: yellow, green, blue, black
- > 4-quad: yellow, green, red, black
- > 5-quad: yellow, green, blue, black
- > 6-quad: yellow, green, red, black
- > 7-quad: orange, green, blue, black

#### Insulation:

- > Solid PE

#### Twisting:

- > Cores stranded in quads
- > Quads stranded in concentric layers

#### Wrapping:

- > One or more layers of plastic tapes

#### Screen:

- > Corrugated copper tape 0.1 mm
- > Longitudinally applied with overlap

#### Outer sheath:

- > FRNC-PE material
- > Black

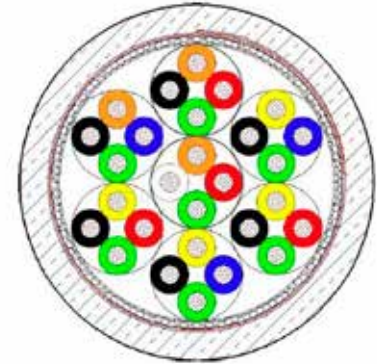

70°



Content is subject to changes acc. to current product development and or any changes to standards.

| No. of pairs        | Outer diameter mm | Weight kg/km | Standard length m | Transport gross weight kg/km | Prysmian EAN no. |
|---------------------|-------------------|--------------|-------------------|------------------------------|------------------|
| FTGS n x 4 x 0.9 mm |                   |              |                   |                              |                  |
| 1 x                 | 9.5               | 110          | 1000 - K8         | 56                           |                  |
| FTGS n x 4 x 1.4 mm |                   |              |                   |                              |                  |
| 1 x                 | 11.5              | 170          | 1000 - K9         | 100                          |                  |
| 3 x                 | 18.0              | 360          | 1000 - K12        | 245                          |                  |
| 5 x                 | 21.5              | 560          | 1000 - K14        | 380                          |                  |
| 7 x                 | 23.5              | 710          | 1000 - K16        | 510                          |                  |
| 10 x                | 29.0              | 990          | 1000 - K18        | 730                          |                  |

## CONTROL

# IFSI-EMC PURE 300/500V

## SCREENED, HALOGEN FREE & FLAME RETARDANT



### Application

Flame-retarded cable for signalling systems indoors and outdoors. Copper screen is 100% dense with low coupling impedance that fulfills the EMC-directive. Cores are numbered and twisted into pairs.

### Technical data

#### Rated voltage:

- > 300/500 V

#### Bending radius:

- > Admissible min: 10 x D

#### Resistance:

- > Conductor:  $\leq 0.9$  or  $1.7 \Omega/\text{km}$
- > Insulation:  $\geq 10 \text{ G}\Omega \times \text{km}$

#### Mutual capacitance at 800-1000 Hz:

- > For  $0.9 \text{ mm}^2$ :  $38 \pm 3 \text{ nF/km}$  (max 45)
- > For  $1.4 \text{ mm}^2$ :  $41 \pm 4 \text{ nF/km}$  (max 48)

#### Dielectric strength at 50 Hz:

- > core/core: 2,500 V rms
- > core/armouring: 2,500 V rms

### Temperature range

- > During installation:  $-10^\circ\text{C}$  to  $+50^\circ\text{C}$
- > In operations:  $-30^\circ\text{C}$  to  $+70^\circ\text{C}$

### Standard & Approval

- > HD 627 7B1 - construction
- > IEC 60502-1 - insulation

### Approval:

- > CPR class: Cca- s1bd1a1

### Construction

#### Conductor:

- > Round
- > Multi-stranded copper wires
- > Acc. to IEC 60228 class 5.

#### Insulation:

- > Cross-linked halogen free polymer

#### Core marking:

- > Repeattitive numbering from 1-4

#### Twisting:

- > Core 1+2 and 3-4 etc. twisted into pairs

#### Filling/wrapping:

- > Halogen free

#### Screen:

- > Copper foil with overlap
- > Concentrically applied

#### Outer sheath:

- > Halogen free polymer
- > Black

### Material property

- > Flame retardant: IEC 60332-3-24
- > Halogen free: IEC 60754-1
- > Acidity: IEC 60754-2
- > Smoke density: IEC 61034

Content is subject to changes acc. to current product development and or any changes to standards.

| Conductor cross-section $\text{mm}^2$ | Outer diameter mm | Weight kg/km | Standard length m | Shipping drum type | Prysmian EAN no. |
|---------------------------------------|-------------------|--------------|-------------------|--------------------|------------------|
| 4 x 0.75                              | 10.5 ± 0.8        | 125          | 1000              | K8                 |                  |
| 8 x 0.75                              | 15.5 ± 0.8        | 230          | 1000              | K11                |                  |
| 12 x 0.75                             | 16.0 ± 0.8        | 263          | 1000              | K11                |                  |
| 20 x 0.75                             | 19.5 ± 0.8        | 388          | 500               | K9                 |                  |
| 28 x 0.75                             | 20.5 ± 1.0        | 484          | 500               | K11                |                  |



## CONTROL

# IFSI-EMC PURE 450/750 V

## SCREENED, HALOGEN FREE & FLAME RETARDANT

### Application

Halogen free, low smoke and flame retardant cable for use in control systems. Also suitable for indoors and outdoors installation as a grounding cable. The copper screen is 100% dense, with low coupling impedance that fulfills the EMC directive.

### Technical data

#### Rated voltage:

- > 450/750 V

#### Temperature range

- > In operations: max. +90°C

### Standard & Approval

#### Standard:

- > HD 627 7B2 - construction
- > IEC 60502-1 - insulation

#### Approval:

- > CPR class: Cca- s1bd1a1

### Construction

#### Conductor:

- > Round
- > Solid copper wires
- > Acc. to IEC 60228 class 1.

#### Insulation:

- > Cross-linked halogen free polymer

#### Filling/wrapping:

- > Halogen free

#### Screen:

- > Copper foil with overlap
- > Concentrically applied

#### Outer sheath:

- > Halogen free polymer
- > Black

### Material property

- > Flame retardant: IEC 60332-3-24
- > Halogen free: IEC 60754-1
- > Acidity: IEC 60754-2
- > Smoke density: IEC 61034



Content is subject to changes acc. to current product development and or any changes to standards.

| Conductor cross-section mm <sup>2</sup> | Outer diameter mm | Weight kg/km | Standard length m | Shipping drum type | Prysmian EAN no. |
|-----------------------------------------|-------------------|--------------|-------------------|--------------------|------------------|
| 5 x 1.5                                 | 13 ± 0.8          | 221          | 1000              | K9                 | 8711401173850    |
| 7 x 1.5                                 | 14 ± 0.8          | 261          | 1000              | K9                 | 8711401170965    |
| 12 x 1.5                                | 17 ± 0.8          | 375          | 1000              | K11                | 8711401152794    |
| 19 x 1.5                                | 20 ± 0.8          | 562          | 500               | K9                 | 8711401154804    |
| 27 x 1.5                                | 23 ± 0.8          | 735          | 500               | K11                | 8711401151094    |
| 37 x 1.5                                | 25.5 ± 0.8        | 932          | 500               | K12                | 8711401171900    |
| 5 x 2.5                                 | 14.5 ± 0.8        | 290          | 500               | K9                 | 8711401167385    |
| 7 x 2.5                                 | 15.5 ± 0.8        | 350          | 500               | K10                | 8711401155160    |
| 12 x 2.5                                | 19.5 ± 0.8        | 522          | 1000              | K11                | 8711401152251    |
| 19 x 2.5                                | 23 ± 1.0          | 795          | 500               | K11                | 8711401155849    |

**R11x**

**15:35**

# Skien

NSB - Stopper ikke m  
Nationaltheatret og T



## ALONG THE TRACK

### QENE

#### OUTDOOR & ARMoured STRANDED LOOSE TUBE

##### Application

Applications include outdoor data communication connections, telecom trunk lines, telecom access net connections and CATV trunk lines. The intended installation method for this cable is for direct burial under general conditions or with risk of severe rodent attack.

##### Technical data

###### Short term tensile strength:

- > 1,800 N

###### Permanent tensile strength:

- > 1,200 N

###### Crush:

- > 3,000 N

###### Impact:

- > 20 Nm

###### Repeated bending:

- > 30 reverse bends, R = 300 mm

###### Torsion:

- > 5 cycles ± 1 turn

###### Kink:

- > No kink at bending radius 12 x D

###### Bending radius:

- > For ≤ 96 fibres: min. 290 mm
- > For ≥ 97 fibres: min. 390 mm

###### Water penetration:

- > No water on free end ( core only)

###### Temperature range

- > Storage: - 60°C to + 60°C
- > Installation: - 30°C to + 60°C
- > Operation: - 60°C to + 70°C

##### Construction

###### Central strength member:

- > 2.5 mm diameter
- > FPR rod

###### Fibre colour code:

- > 1 red, 2 green, 3 blue, 4 yellow, 5 white
- > 6 grey, 7 brown, 8 violet, 9 turquoise,
- > 10 black, 11 orange, 12 pink.

###### Loose tube:

- > 2.3 mm diameter gel filled loose tubes
- > 12 fibers in each

###### Water blocking:

- > Swellable tape and yarn

###### Wrapping:

- > Polyester tape

###### Rip cord:

- > 1 rip cord

###### Inner sheath:

- > Black MDPE acc. to IEC 60811 & 60708

###### Rip cord:

- > 2 rip cords

###### Armouring:

- > Corrugated steel tape 1,5 mm

###### Outer sheath:

- > Black MDPE acc. to IEC 60811 & 60708

##### Standard

- > EN 187 000
- > IEC 60794-3
- > IEC 60794-3-10
- > IEC 60794-3-12
- > ISO 11801 2nd edition
- > EN 50 173-1



Content is subject to changes acc. to current product development and/or any changes to standards.

| Product description | Fibre count | Outer diameter mm | Weight kg/km | Fibre type     | Product code |
|---------------------|-------------|-------------------|--------------|----------------|--------------|
| 2 x 12              | 24          | 14,5              | 195          | OS2 Singlemode | 60019390     |
| 3 x 12              | 36          | 14.5              | 195          | OS2 Singlemode | 60019480     |
| 4 x 12              | 48          | 14.5              | 195          | OS2 Singlemode | 60019391     |

## ALONG THE TRACK

### AINI

#### UNIVERSAL, ARMoured & WATER PROOF



#### Application

Universal distribution or mini-break-out cable for indoor and outdoor application in LAN and WAN backbones, central office interconnections and backbones in data centres. Suitable for installation in ducts, on trays and directly buried. Designed with double sheathing where the outer one is both UV stabilised, water and moisture resistant. Between the two sheaths there is a steel tape armouring making the cable rodent proof.

#### Technical data

##### Impact:

- > 20 Nm

##### Crush:

- > 3,000 N / 100 mm

##### Torsion:

- > 5 cycles  $\pm$  1 turn

##### Kink:

- > No kink at bending radius 12 x D

##### Bending radius:

- > For stranded fibres: min. 20 mm
- > For MaxCap-BB-Omx fibres: min. 7.5 mm
- > For BendBright XS fibres: min. 7.5 mm

#### Temperature range

- > Storage: - 40°C to + 70°C
- > Installation: - 20°C to + 70°C
- > Operation: - 20°C to + 70°C

#### Material property

- > Flame retardant: IEC 60332-1-2
- > Acidity: IEC 60754-2
- > Smoke density: IEC 61034

#### Construction

##### Fibre:

- > 2-24 tight buffered fibres
- > 900  $\mu$ m  $\pm$  50  $\mu$ m

##### Fibre colour code:

- > 1 red, 2 green, 3 blue, 4 yellow, 5 white, 6 grey, 7 brown, 8 violet, 9 turquoise, 10 black, 11 orange, 12 pink

##### Fibre colour code with mark every 70 mm

- > 13 yellow, 14 white, 15 grey, 16 turquoise, 17 orange, 18 pink

##### Fibre colour code with mark every 35 mm

- > 19 yellow, 20 white, 21 grey, 22 turquoise, 23 orange, 24 pink

##### Strength member:

- > Ultra high modulus aramid yarns

##### Inner sheath:

- > Thermoplastic sheathing compound
- > Acc. to EN 50290-2-27.
- > Halogen free and flame retardant
- > UV stabilised

##### Armouring:

- > Corrugated steel tape 0,15 mm

##### Outer sheath:

- > 1.5 mm FireBur® material
- > Flame retardant and UV stabilised
- > Acc. to EN 50290-2-27
- > Blue

#### Standard & Approval

##### Standard:

- > ISO 11801 2nd edition, EN 187 000
- > IEC 60794-1 & 2, EN 50 173-1
- > IEC 60794-2-20

##### Approval:

- > CPR class: Eca

Content is subject to changes acc. to current product development and or any changes to standards.

| Fibre count | Outer diameter mm | Weight kg/km | Installation load max. N | Tensile strength N |           | Bending radius |      |
|-------------|-------------------|--------------|--------------------------|--------------------|-----------|----------------|------|
|             |                   |              |                          | Short term         | Permanent | Min.           | Max. |
| 2           | 8.5               | 90           | 1,000                    | 560                | 280       | 130            | 170  |
| 4           | 8.5               | 90           | 1,000                    | 560                | 280       | 130            | 170  |
| 6           | 11.0              | 130          | 1,000                    | 560                | 280       | 170            | 220  |
| 8           | 11.0              | 130          | 1,000                    | 560                | 280       | 170            | 220  |
| 12          | 11.0              | 130          | 1,200                    | 680                | 340       | 170            | 220  |
| 16          | 11.0              | 230          | 1,200                    | 680                | 340       | 170            | 220  |
| 24          | 14.0              | 230          | 2,000                    | 1,000              | 500       | 200            | 260  |

## ALONG THE TRACK

# AIAI

## UNIVERSAL, WATER PROOF & ROBUST

### Application

Universal distribution or mini-break-out cable suited for indoor and outdoor applications such as LAN and WAN backbones, central office inter-connections, backbones in data centres and many other applications. Suitable for installation on trays or directly buried in ducts that occasionally floods. Designed with double sheathing that makes it UV stabilised, water and moisture resistant. Between the two sheaths there is a layer of coated and water blocking glass yarns, giving the cable a very high tensile strength and a degree of rodent protection.

### Technical data

#### Impact:

- > 15 Nm

#### Crush:

- > 2,000 N / 100 mm

#### Torsion:

- > 5 cycles ± 1 turn

#### Bending radius:

- > For stranded fibres: min. 20 mm
- > For Max-Cap-BB-Omx fibres: min. 7.5 mm
- > For BendBright XS fibres: min. 7.5 mm

### Temperature range

- > Storage: - 40°C to + 70°C
- > Installation: - 20°C to + 70°C
- > Operation: - 20°C to + 70°C

### Material property

- > Flame retardant: IEC 60332-1
- > Acidity: IEC 60754-2
- > Smoke density: IEC 61034

### Construction

#### Fibre:

- > 2-24 tight buffered fibres
- > 900 µm ± 50 µm

#### Fibre colour code:

- > 1 red, 2 green, 3 blue, 4 yellow, 5 white
- > 6 grey, 7 brown, 8 violet, 9 turquoise, 10 black, 11 orange, 12 pink

#### Fibre colour code with mark every 70 mm

- > 13 yellow, 14 white, 15 grey, 16 turquoise, 17 orange, 18 pink

#### Fibre colour code with mark every 35 mm

- > 19 yellow, 20 white, 21 grey, 22 turquoise, 23 orange, 24 pink

#### Strength member:

- > Ultra high modulus aramid yarns

#### Inner sheath:

- > LZSH compound
- > Acc. to EN 50290-2-27.
- > Halogen free and flame retardant
- > UV stabilised

#### Reinforcement:

- > Coated glass yarns

#### Ripcord:

- > Polyester

#### Outer sheath:

- > 1.2 mm FireBur® material
- > Flame retardant and UV stabilised
- > Acc. to EN 50290-2-27
- > Blue

### Standard

- > ISO 11801 2nd edition
- > EN 187 000
- > IEC 60794-2
- > EN 50 173-1
- > IEC 60794-2-20



Content is subject to changes acc. to current product development and or any changes to standards.

| UC FIBRE I/O DI LSHF   |             |                   |                   |                               |                              |                        |                        |
|------------------------|-------------|-------------------|-------------------|-------------------------------|------------------------------|------------------------|------------------------|
| Cable type description | Fibre count | Outer diameter mm | Weight nom. kg/km | Tensile strength short term N | Tensile strength permanent N | Bending radius min. mm | Prysmian material code |
| D DA ES9 61 BL         | 2           | 9                 | 80                | 2,700                         | 1,300                        | 110                    | 60033616               |
| D DA ES9 61 BL         | 4           | 9.5               | 85                | 2,700                         | 1,300                        | 105                    | 60033615               |
| ES9 OM4B BL            | 24          | 13                | 140               | 3,600                         | 1,800                        | 130                    | 60036524               |
| D DA ES9 OM3B BL       | 4           | 9,5               | 85                | 2,700                         | 1,300                        | 105                    | 60041029               |
| D DA ES9 SM2D          | 16          | 11                | 115               | 3,200                         | 1,600                        | 120                    | 60042476               |
| ES9 SM2D.P BL          | 24          | 13                | 140               | 3,600                         | 1,800                        | 130                    | 60047265               |



## ALONG THE TRACK

### QXAE

#### OUTDOOR STRANDED LOOSE TUBE



##### Application

Outdoor cable for LAN, MAN and telecom backbone installations direct in the ground or in trenches using ploughing method. Designed with a layer of coated and water blocking glass yarns, giving the cable a very high tensile strength and a degree of rodent protection.

##### Technical data

Short term tensile strength:

- > 5,000 N

Permanent tensile strength:

- > 3,500 N

Crush:

- > 3,000 N

Impact:

- > 20 Nm

Torsion:

- > 5 cycles  $\pm$  1 turn

Kink:

- > No kink at bending radius 12 x D

Bending radius:

- > For 72 fibres: min. 150 mm
- > For 96 fibres: min. 175 mm

Water penetration:

- > No water on free end

Temperature range

- > Storage: - 40°C to + 70°C
- > Installation: - 40°C to + 70°C
- > Operation: - 40°C to + 70°C

##### Construction

Central strength member:

- > 2.5 mm diameter, FPR rod

Loose tube:

- > Gel filled loose tube
- > 2.3 mm diameter
- > 12 fibres in each
- > Up to 18 tubes in to layers

Water blocking:

- > Swellable tape and yarn

Wrapping:

- > Swellable tape

Reinforcement:

- > Heavy layer of glass yarns

Rip cord:

- > Polyester

Outer sheath:

- > MDPE 1.5 mm
- > Black
- > Acc. to IEC 60811 & 60708

##### Standard

- > EN 187 000
- > IEC 60794-3
- > IEC 60794-3-10
- > IEC 60794-3-12
- > ISO 11801 2nd edition
- > EN 50 173-1

Content is subject to changes acc. to current product development and or any changes to standards.

#### UC FIBRE O ST D DA PE 5,0 kN

| Cable type description  | Fibre count no. | Outer diamter nom.mm | Weight nom. kg/km | Bending radius min. mm | Fibre type                                           | Prysmian article no. |
|-------------------------|-----------------|----------------------|-------------------|------------------------|------------------------------------------------------|----------------------|
| 8 x 12 OM4B             | 96              | 13                   | 140               | 175                    | MaxCap-BB-OM4                                        | 60027623             |
| 6 x 12 SM2D             | 72              | 11                   | 105               | 150                    | OS2 Singlemode                                       | 60019579             |
| 8 x 12 SM2D             | 96              | 13                   | 140               | 175                    | OS2 Singlemode                                       | 60019153             |
| 2 x 12 SM2D 4x12 MM61   | 72              | 11                   | 105               | 150                    | Hybrid OS2 24 Singlemode + 48 OM1 62.5/125 multimode | 60024964             |
| 4 x 12 SM2D 4 x 12 OM2B | 96              | 13                   | 140               | 175                    | Hybrid OS2 48 Singlemode + 48 MaxCap-BB-OM2          | 60031874             |

## ALONG THE TRACK

### QINI

## UNIVERSAL & ARMoured STRANDED LOOSE TUBE

#### Application

Armoured outdoor cable for data communication connections, CATV trunk lines, telecom trunk lines and telecom access net connections. For direct burial in general conditions or with risk of severe rodent attacks.

#### Technical data

##### Short term tensile strength:

- > 1,800 N

##### Permanent tensile strength:

- > 1,200 N

##### Crush:

- > 3,000 N

##### Impact:

- > 20 Nm

##### Repeated bending:

- > 30 reverse bends, R = 300 mm

##### Torsion:

- > 5 cycles ± 1 turn

##### Kink:

- > No kink at bending radius 12 x D

##### Bending radius:

- > Min. 290 mm

##### Water penetration:

- > No water on free end ( core only)

#### Temperature range

- > Storage: - 60°C to + 60°C
- > Installation: - 30°C to + 60°C
- > Operation: - 60°C to + 70°C

#### Construction

##### Central strength member:

- > 2.5 mm diameter, FPR rod

##### Fibre colour code:

- > 1 red, 2 green, 3 blue, 4 yellow, 5 white
- 6 grey, 7 brown, 8 violet, 9 turquoise,
- 10 black, 11 orange, 12 pink.

##### Loose tube:

- > Gel filled loose tubes
- > 2.3 mm diameter
- > 12 fibers in each

##### Water blocking:

- > Swellable tape and yarn

##### Wrapping:

- > Polyester tape

##### Rip cord:

- > 1 rip cord

##### Inner sheath:

- > Blue FireBur® acc. to EN 50290-2-27

##### Rip cord:

- > 1 rip cord

##### Armouring:

- > Corrugated steel tape 0.155 mm

##### Outer sheath:

- > Blue FireBur® 1.5 mm
- > Ac. to EN 50290-2-27

#### Standard

- > IEC 60794-3
- > IEC 60794-3-10
- > IEC 60794-3-12
- > EN 50 173-1
- > ISO 11801 2nd edition

#### Material property

- > Flame retardant: IEC 60332-1
- > Halogen free: IEC 60754-1
- > Acidity: IEC 60754-2
- > Smoke density: IEC 61034



Content is subject to changes acc. to current product development and or any changes to standards.

| Fibre count | Outer diameter mm | Weight nom. kg/km | Tensile strength short term N | Bending radius min.mm | Fibre type     | Product article no. |
|-------------|-------------------|-------------------|-------------------------------|-----------------------|----------------|---------------------|
| 24          | 14.5              | 225               | 1800                          | 290                   | OS2 Singlemode |                     |
| 48          | 14.5              | 225               | 1800                          | 290                   | OS2 Singlemode | 60029965            |
| 72          | 14.5              | 225               | 1800                          | 290                   | OS2 Singlemode | 60020577            |
| 96          | 19.5              | 220               | 1800                          | 290                   | OS2 Singlemode |                     |

## ALONG THE TRACK

# QXXE 0/DT-JM/W

## WEATHER PROOF & DRY CORE LOOSE TUBE

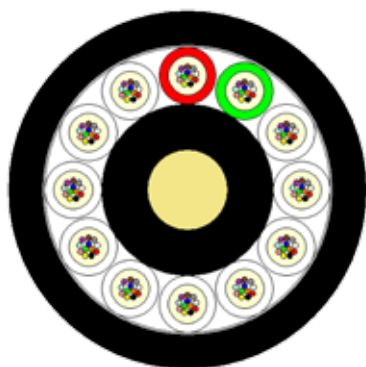

### Application

Outdoor weather proof and robust cable with HDPE sheath for blowing in pipes or direct installation in ducts. Both metal and halogen free. Core is dry with swellable materials and grease-filled fibre tubes to prevent longitudinal water penetration.

### Technical data

#### Short term tensile strength:

- > 2,700 N (24 -144 mm<sup>2</sup>)
- > 2,000 N (192 mm<sup>2</sup>)

#### Permanent tensile strength:

- > 1,000 N

#### Crush:

- > 3,000 N

#### Impact:

- > 15 Nm

#### Bending:

- > < 0,05 dB no damage

#### Kink:

- > < 0,05 dB no damage

#### Water penetration:

- > < 3 m/24 hours

### Temperature range

- > Storage: - 40°C to + 70°C
- > Installation: - 15°C to + 60°C
- > Operation: - 40°C to + 70°C

### Construction

#### Central strength member:

- > 2.1 - 3.5 mm diameter, FPR rod

#### Loose tube:

- > 2.5 or 3.0 mm diameter
- > Grease filled
- > SZ twisted around FPR rod

#### Water blocking:

- > Swellable material
- > Dry core

#### Rip cord:

- > 1 rip cord

#### Outer sheath:

- > HDPE 1.5 mm
- > Black

### Standard

- > EN 187000, EN 1871000
- > EN 187101, EN 188000
- > EN 60793, IEC 60794
- > ITU-T REC G650, REC G652

### Material property

- > Halogen free: IEC 60754-1

Content is subject to changes acc. to current product development and or any changes to standards.

| Fibre count | Outer diameter nom. mm | Weight nom. kg/km | Number of tubes and fillers | Bending radius max. mm | Bending radius min. mm | Prysmian article no. |
|-------------|------------------------|-------------------|-----------------------------|------------------------|------------------------|----------------------|
| 12          | 10.6                   | 85                | 1 + 5                       | 212                    | 106                    | 60046044             |
| 24          | 10.6                   | 85                | 2 + 4                       | 212                    | 106                    | 60046182             |
| 48          | 10.6                   | 85                | 4 + 2                       | 212                    | 106                    | 60046045             |
| 96          | 12.2                   | 120               | 8 + 0                       | 244                    | 122                    | 60046043             |
| 144         | 15.5                   | 190               | 12 + 0                      | 310                    | 155                    | 60046046             |
| 192         | 14.2                   | 160               | 8 + 0                       | 284                    | 142                    | 60046047             |

## ALONG THE TRACK

# QANE

## OUTDOOR & ARMoured CENTRAL LOOSE TUBE

### Application

Suitable for LAN and WAN backbones, telecom access lines, fibre to business and fibre to the building drop connections as well as fibre to the home drop and access connections. MDPE sheathing ideal for outdoor installation and corrugated steel tape armouring makes it rodent proof. Applicable for installation in ducts and on trays as well as for direct burial with proper sand back filling.

### Technical data

#### Short term tensile strength:

- > 1,000 N

#### Permanent tensile strength:

- > 500 N

#### Crush:

- > 2,000 N

#### Impact:

- > 10 Nm

#### Torsion:

- > 5 cycles  $\pm$  1 turn

#### Kink:

- > No kink at loop diameter of 100 mm

#### Bending radius:

- > Min. unloaded: R=55 mm
- > Min. loaded: R=110 mm

### Temperature range

- > Storage: - 40°C to + 70°C
- > Installation: - 40°C to + 70°C
- > Operation: - 40°C to + 70°C

### Construction

#### Loose tube:

- > 2.8 or 3.5 mm diameter
- > Gel-filled
- > 2-6 or 24 fibers in each

#### Fibre colour code:

- > 1 red, 2 green, 3 blue, 4 yellow, 5 white, 6 grey, 7 brown, 8 violet, 9 turquoise, 10 black, 11 orange, 12 pink

#### Fibre colour code with mark every 70 mm

- > 13 yellow, 14 white, 15 grey, 16 turquoise, 17 orange, 18 pink

#### Fibre colour code with mark every 35 mm

- > 19 yellow, 20 white, 21 grey, 22 turquoise, 23 orange, 24 pink

#### Strength member:

- > E-glass yarns

#### Armouring:

- > Corrugated steel tape 0.15 mm

#### Outer sheath:

- > MDPE 1.5 mm
- > Acc. to IEC 60811, IEC 60708
- > Black

### Standard

- > IEC 60794-1
- > EN 50 173-1
- > ISO 11801 2nd edition



Content is subject to changes acc. to current product development and or any changes to standards.

| Fibre count | Outer diameter mm | Weight nom. kg/km | MaxCap-BB OM2 fibres | MaxCap-BB OM3 fibres | MaxCap OM4 fibres | OM1 62.5/125 multimode | OS2 singlemode |
|-------------|-------------------|-------------------|----------------------|----------------------|-------------------|------------------------|----------------|
| 2           | 8.5               | 75                | 60024911             |                      |                   | 60019683               | 60018976       |
| 4           | 8.5               | 75                | 60011387             | 60018856             |                   | 60018741               | 60018850       |
| 6           | 8.5               | 75                | 60018892             | 60019590             |                   | 60018743               | 60018744       |
| 8           | 8.5               | 75                | 60018893             | 60019384             | 60043719          | 60018746               | 60018931       |
| 12          | 8.5               | 75                | 60018894             | 60011435             | 60019807          | 60018749               | 60018750       |
| 16          | 8.5               | 75                |                      | 60019386             |                   | 60011298               | 60011340       |
| 24          | 8.5               | 80                | 60018895             | 60019387             | 60043985          | 60011745               | 60018751       |

## ALONG THE TRACK

### QXXI-I/O

#### INDOOR/OUTDOOR STRANDED LOOSE TUBE

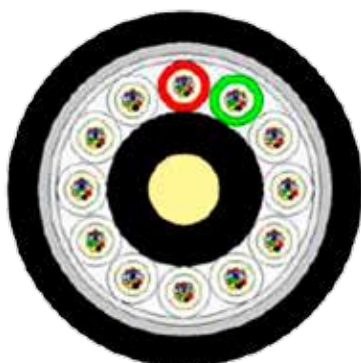

#### Application

Indoor/Outdoor backbone cable for LAN, WAN and telecom backbone installations. Robust dielectric design with a wide temperature range. The core is dry and water protected by dry water blocking technology.

#### Technical data

Short term tensile strength:

- > 2,700 N

Tensile strength:

- > 900 N

Crush:

- > 3,000 N

Impact:

- > 15 Nm, R=300

Torsion:

- > 100 N, 10 cycles

Repeated bending:

- > R=20 x D, 100 N, 35 cycles

Cable bend:

- > R=20 x D, 4 turns, 3 cycles

Bending radius:

- > Loaded: min. 20 x D
- > Unloaded: min. 10 x D

Water penetration:

- > 3 m/24 hours - no water leakage

#### Temperature range

- > Storage: - 40°C to + 70°C
- > Installation: - 30°C to + 60°C
- > Operation: - 40°C to + 70°C

#### Standard

- > IEC 60794-3-10

#### Construction

Central strength member (CSM):

- > Glass fibre reinforced plastic rod, FPR
- > Plastic overshooting when needed

Loose tube:

- > Thermoplastic material
- > Up to 12 fibres per tube
- > Filled with watertight compound

Fibre colour code:

- > 1 blue, 2 yellow, 3 red, 4 white, 5 green
- > 6 violet, 7 orange, 8 grey, 9 aqua
- > 10 black, 11 brown, 12 pink

Filler:

- > Thermoplastic rods, where needed

Stranding:

- > SZ stranded around the CSM rod

Water blocking:

- > Longitudinal watertight
- > Water swellable material
- > Dry core

Strength member:

- > Glass yarns, when needed

Rip cord:

- > 2 rip cords

Outer sheath:

- > HFFR compound
- > Black

#### Material property

- > Flame retardant: IEC 60332-1
- > Halogen free: IEC 60754-1
- > Acidity: IEC 60754-2
- > Smoke density: IEC 61034

Content is subject to changes acc. to current product development and or any changes to standards.

| No. of fibres                 | 12     | 24     | 36     | 48     | 60     | 72   | 84     | 96     |
|-------------------------------|--------|--------|--------|--------|--------|------|--------|--------|
| No. tubes x no. fibres        | 5 x 12 | 5 x 12 | 5 x 12 | 5 x 12 | 5 x 12 | 6x12 | 8 x 12 | 8 x 12 |
| Loose tube/filler diameter mm | 2.5    | 2.5    | 2.5    | 2.5    | 2.5    | 2.5  | 2.5    | 2.5    |
| CSM diameter mm               | 2.1    | 2.1    | 2.1    | 2.1    | 2.1    | 2.6  | 3.0    | 3.0    |
| CSM oversheathing diameter mm | -      | -      | -      | -      | -      | -    | 4.2    | 4.2    |
| Outer sheath thickness mm     | 1.5    | 1.5    | 1.5    | 1.5    | 1.5    | 1.5  | 1.5    | 1.5    |
| Cable diameter mm             | 11.0   | 11.0   | 11.0   | 11.0   | 11.0   | 11.5 | 12.5   | 12.5   |
| Cable weight kg/km            | 110    | 110    | 110    | 110    | 110    | 120  | 150    | 150    |



## AERIAL

# QEAE KOMBI

## OUTDOOR ADSS STANDED LOOSE TUBE

### Application

Aerial outdoor cable (ADSS-All Dielectric Self Support design) for LAN, MAN and telecom backbone installations. The robust design include double sheathing, with a thick layer of aramid yarn in between. The cable is also suitable for duct installation. The core is dry and water protected by dry water blocking technology.

### Technical data

#### Short term tensile strength:

- > 1,800 N

#### Permanent tensile strength:

- > 2,000 N
- > 1,600 N

#### Crush:

- > 2,000 N / 100 mm, max 15 min.
- > 1,500 N / 25 mm, max 15 min.

#### Impact:

- > 10 Nm, 3 impacts, R=300 mm

#### Cable bend:

- > R=20 x D, 4 turns, 3 cycles

#### Bending radius:

- > Loaded: min. 20 x D
- > Unloaded: min. 15 x D

#### Water penetration:

- > 3 m/24 hours - no water leakage

### Temperature range

- > Storage: - 40°C to + 70°C
- > Installation: - 10°C to + 60°C
- > Operation: - 40°C to + 60°C

### Standard

- > IEC 60794-1-2

### Construction

#### Central strength member (CSM):

- > Glass fiber reinforced plastic rod, FPR
- > Plastic oversheathing when needed

#### Loose tube:

- > Thermoplastic material
- > Up to 12 fibres per tube
- > Filled with water-tightness compound

#### Fibre colour code:

- > 1 white, 2 red, 3 yellow, 4 green, 5 blue
- 6 grey, 7 brown, 8 black, 9 violet, 10 aqua
- 11 orange, 12 pink.

#### Filler:

- > Thermoplastic rods, where needed

#### Stranding:

- > Loose tubes and filler
- > SZ stranded around the CSM rod

#### Water blocking:

- > Longitudinal watertight
- > Water swellable material
- > Dry core

#### Rip cord:

- > 1 rip cord

#### Inner sheath:

- > Polyethylene

#### Peripheral reinforcement:

- > Aramid yarns

#### Rip cord:

- > 1 rip cord

#### Outer sheath:

- > HDPE, minimum 1.5 mm
- > Black



60°

Content is subject to changes acc. to current product development and or any changes to standards.

| No. of fibres                 | 12     | 24     | 48     | 96      | 144     |
|-------------------------------|--------|--------|--------|---------|---------|
| No. tubes x no. fibres        | 1 x 12 | 2 x 12 | 4 x 12 | 8 x 12  | 12 x 12 |
| Loose tube/filler diameter mm | 2.8    | 2.8    | 2.8    | 2.8     | 2.8     |
| CSM oversheathing diameter mm | 3.0    | 3.0    | 3.0    | 3.5/4.8 | 3.5/8.6 |
| Cable diameter mm             | 14.8   | 14.8   | 14.8   | 16.4    | 20.0    |
| Cable weight kg/km            | 170    | 170    | 170    | 210     | 305     |

## AERIAL

### QXWE-7.0

#### OUTDOOR FIGURE 8 STRANDED LOOSE TUBE

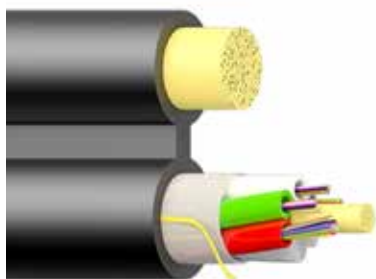

70°

#### Application

Optical cable for aerial installation on poles. The outer sheath is made of abrasion resistant polyethylene. The cable has a non-metallic FRP messenger wire suitable for up to 250 m span lengths. Span length is dependent on ice load, wind load and installation sag. The figure-8 construction allows easy installation with cable grips attached to the messenger wire. The core is dry and water protected by dry water blocking technology. The cable is completely non-metallic to eliminate any problem with induced electrical currents.

#### Technical data

##### Short term tensile strength:

- > 9,000 N

##### Permanent tensile strength:

- > 9,000 N

##### Crush:

- > 1,000 N

##### Impact:

- > 15 Nm, 3 impacts, R=300 mm

##### Cable bend:

- > R ≤ 250 mm with messenger
- > R=10 x D, 4 turns, 3 cycles

##### Bending radius:

- > Loaded: min. 15 x D
- > Unloaded: min. 10 x D

##### Water penetration:

- > 3 m/24 hours - no water leakage

##### Web dimensions(WxH):

- > 2.5 ± 0.5 x 3.0 ± 1.0

##### Temperature range

- > Storage: - 40°C to + 70°C
- > Installation: - 15°C to + 60°C
- > Operation: - 40°C to + 70°C

##### Standard

- > IEC 60794-1-2

#### Construction

##### Messenger:

- > Glass fibre reinforced plastic rod, FPR
- > 7.0 mm

##### Central strength member (CSM):

- > Glass fibre reinforced plastic rod, FPR
- > Plastic oversheathing when needed

##### Loose tube:

- > Thermoplastic material
- > Up to 24 fibres per tube
- > Filled with watertight compound

##### Fibre colour code:

- > 1 white, 2 red, 3 yellow, 4 green, 5 blue
- > 6 grey, 7 brown, 8 black, 9 violet, 10 aqua
- > 11 orange, 12 pink.

##### Tube colour code:

- > 1 red, 2 green, 3-12 white

##### Stranding:

- > SZ stranded around the CSM rod
- > White-red identification thread

##### Water blocking:

- > Longitudinal watertight
- > Water swellable material
- > Dry core

##### Rip cord:

- > 2 rip cords

##### Outer sheath:

- > HDPE, minimum 1.5 mm
- > Black

#### Delivery

- > Standard length: 2 or 4 km

Content is subject to changes acc. to current product development and or any changes to standards.

| No. of fibres                 | 12     | 24     | 48     | 72     | 96     |
|-------------------------------|--------|--------|--------|--------|--------|
| No. tubes x no. fibres        | 1 x 12 | 2 x 12 | 4 x 12 | 6 x 12 | 8 x 12 |
| Loose tube/filler diameter mm | 2.5    | 2.5    | 2.5    | 2.5    | 2.5    |
| CSM diameter mm               | 2.6    | 2.6    | 2.6    | 2.6    | 2.6    |
| CSM oversheathing diameter mm | -      | -      | -      | -      | 4.2    |
| Cable diameter mm             | 10.8   | 10.8   | 10.8   | 10.8   | 12.4   |
| Cable weight kg/km            | 215    | 215    | 215    | 220    | 250    |

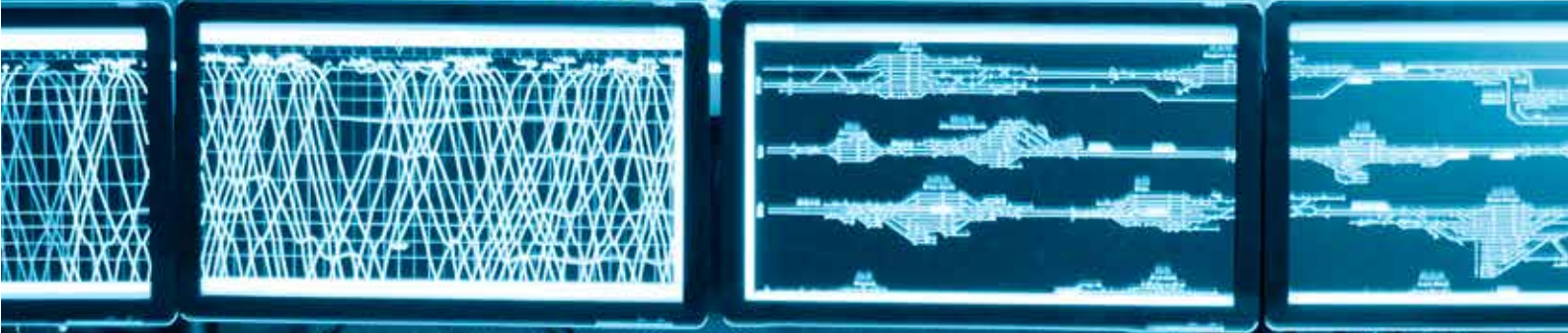
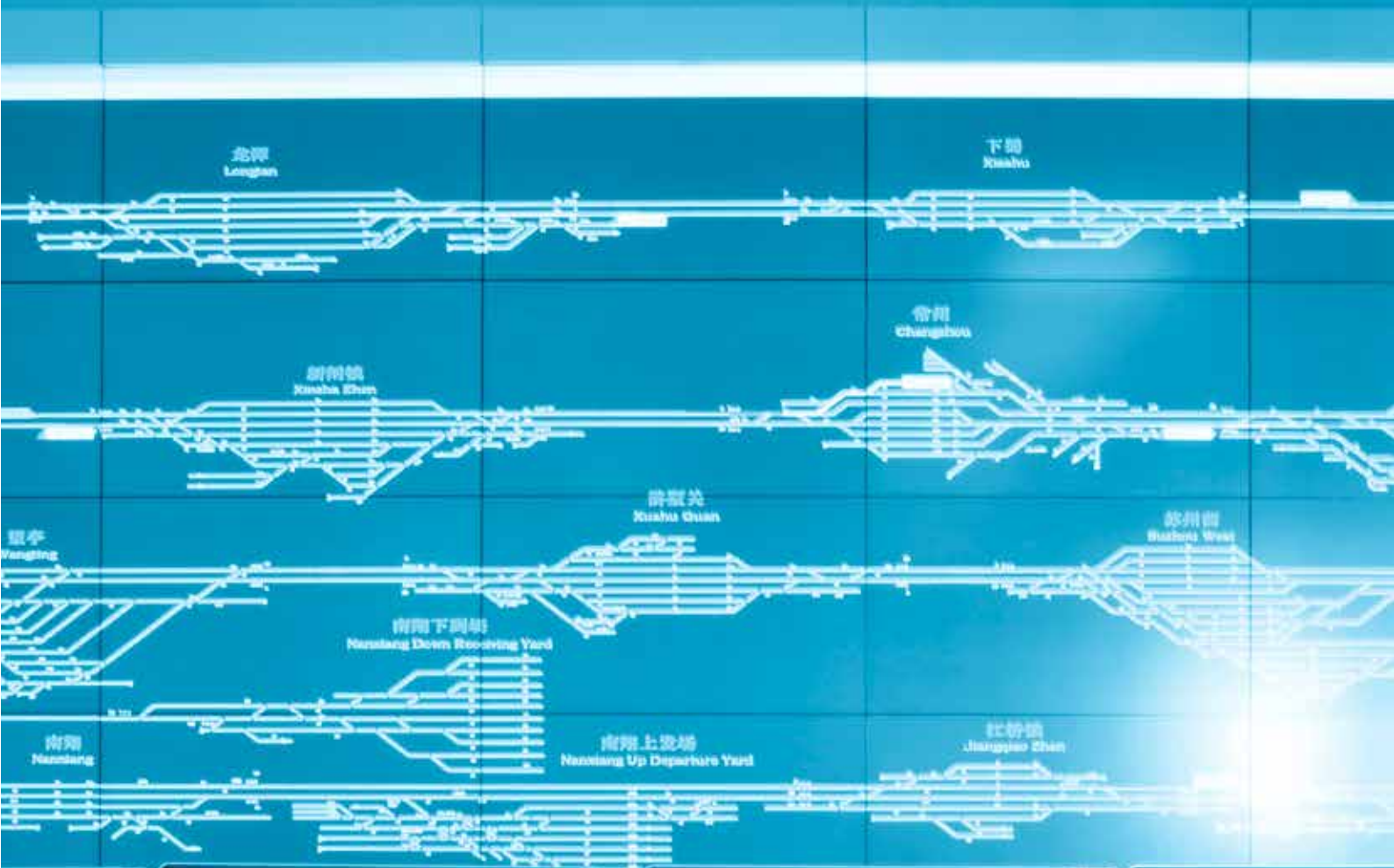

## CONNECTIVITY

# ORP 250 DISTRIBUTION PANEL UNIVERSAL 19" METALLIC RACK WITH STORAGE



### Application

Robust metallic ORP distribution panel designed for dry indoor termination and distribution of fibre optic cables in telecommunications, CATV and LAN networks. In a fibre optic network this panel works as a cross-connection and testing point between the optical cable network and the equipment.

Universal type of FO distribution panel for 19" racks. Contains a splicing section, patch panel and cover. Position of the panel can be adjusted freely.

ORP-250 also contains a storage shelf for excess lengths of patch cords

The constructions of the panel is simple and modular and independent of cable constructions. Easy to install, maintain and upgrade to higher capacity systems.

Entrance for two cables or multiple small size cables from the back of the panel. Fusion splice protection sleeve holders of rubber material attached to the bottom of the panel.

Additional materials such as adaptors, pigtails, slice protectors and grounding parts must be ordered seperately.

### Construction

#### Distribution panel:

- > For 19" racks
- > Splicing section
- > Patch panel, adjustable
- > Protection sleeve holder
- > Cover
- > Storage shelf, adjustable
- > Modular designed
- > Powder painted and zink coated steel

#### Entry ports:

- > On back
- > For 2 large or several small cables

#### Splice section capacity:

- > 48 - 96 fusion splices
- > Double connector adaptors (SC-D)
- > Heat shrinkable

#### Patch panel capacity:

- > 24 connection adaptors
- > SC, SC-D (SC duplex), LC duplex, LC Quad ST, FC\*D or 12 RJ45

#### Grounding of metallic parts:

- > Use part KT-1070 - order separately
- > Use part FT-920- order separately

#### Dimensions (h x w x d):

- > 60 (2U) x 440 (19") x 230 mm

#### Weight

- > 2.9 kg

Content is subject to changes acc. to current product development and or any changes to standards.

| Product type and name | Prysmian part no. |
|-----------------------|-------------------|
| ORP-250 SC ODF        | XEXSC01664        |
| ORP-250 SC-D ODF      | XEXSC01665        |
| ORP-250 LC ODF        | XEXSC01923        |
| ORP-250 ST/FC*D ODF   | XEXSC01666        |
| ORP-250 LC-Q ODF      | XEXSC02051        |

## CONNECTIVITY

# ORP 260 DISTRIBUTION PANEL

## UNIVERSAL 19" METALLIC RACK



### Application

Robust metallic ORP distribution panel designed for dry indoor termination and distribution of fibre optic cables in telecommunications, CATV and LAN networks. In a fibre optic network this panel works as a cross-connection and testing point between the optical cable network and the equipment.

Universal type of FO distribution panel for 19" racks. Contains a splicing section, patch panel and cover. Position of the panel can be adjusted freely.

The constructions of the panel is simple and modular and independent of cable constructions. Easy to install, maintain and upgrade to higher capacity systems.

Entrance for two cables or multiple small size cables from the back of the panel. Fusion splice protection sleeve holders of rubber material attached to the bottom of the panel.

Additional materials such as adaptors, pigtails, slice protectors and grounding parts must be ordered separately.

### Construction

#### Distribution panel:

- > For 19" racks
- > Splicing section
- > Patch panel, adjustable
- > Protection sleeve holder
- > Cover
- > Modular designed
- > Powder painted and zink coated steel

#### Entry ports:

- > On back
- > For 2 large or several small cables

#### Splice section capacity:

- > 48 - 96 fusion splices
- > Double connector adaptors (SC-D)
- > Heat shrinkable

#### Patch panel capacity:

- > 24 connection adaptors
- > SC, SC-D (SC duplex), LC duplex, LC Quad ST, FC\*D or 12 RJ45

#### Grounding of metallic parts:

- > Use part KT-1070 - order separately
- > Use part FT-920- order separately

#### Dimensions (h x w x d):

- > 45 (1U) x 440 (19") x 230 mm

#### Weight

- > 1.9 kg

Content is subject to changes acc. to current product development and or any changes to standards.

| Product type and name                 | Prysmian part no. |
|---------------------------------------|-------------------|
| ORP-260 SC ODF                        | XEXSC01664        |
| ORP-260 12xRJ45 ODF                   | XEXSC01862        |
| ORP-260 SC-D ODF                      | XEXSC01668        |
| ORP-260 LC-Q ODF                      | XEXSC02052        |
| ORP-260 LC ODF                        | XEXSC01924        |
| FT-920 Guiding support                | XEXSC01785        |
| ORP-260 ST/FC*D ODF                   | XEXSC01669        |
| KT-1070 Grounding partfor ORP-250/260 | XEXSC02104        |



## CONNECTIVITY

# XOK JOINT CLOSURE

## MULTIPLE OUTDOOR APPLICATION IP68



### Application

Universal joint closure designed to provide water and pressure tight environmental protection for optical fibres and optical fibre splices, regardless of the cable design.

Application ranges from aerial pole or tower, duct to buried or manhole installations. The closure has anchoring points for strength members and facilities for earthing of metallic elements.

The splice organizer trays offer holders for heat shrink splice protectors and sufficient space for storage of spare fibres. The closure is easily assembled and re-entered.

The closure is available in seven basic configurations with two, three or four cable entrances. XOK A3/A4 branch joint closures and extension collars for more cable outlets are also available. Additional materials such as adaptors, pigtails, splice protectors and grounding parts must be ordered separately.

### Technical data

#### Impact resistance:

- > 30 Nm acc. to IEC 60794-1-E4

#### Crush resistance:

- > 1,000 N

#### Bending radius:

- > For fibres: 30 mm

#### Cable retention:

- > 1,000 N acc. to IEC 60794-1-E1

#### Water resistance:

- > Rating IP68

#### Torsion resistance:

- > <0.1 dB acc. to IEC 60794-1-E7

#### Temperature range

- > Storage: - 40°C to + 50°C
- > Installation: - 10°C to + 50°C
- > Operation: - 45°C to + 80°C

### Construction

#### Joint closure:

- > Universally applicable
- > Modular design - 3 sizes
- > Stainless steel housing 1.5 mm
- > Acid and weather resistant
- > No additional protection needed

#### Entry ports:

- > Several configurations
- > From 2 to 4 cable entry ports
- > Round or oval

#### Splice capacity:

- > XOK 103: 4 trays x 48 splices = 192
- > XOK 107: 7 trays x 48 splices = 336
- > XOK A3: 4 trays x 48 splices = 1000 using extension collars or splice trays for fibre ribbons

#### Closure sealing:

- > Mechanical entry port sealing
- > Heat shrink entry port sealing
- > Watertight seal, IP68
- > High cable pull strength

#### Anchoring point:

- > Anchor points for strength member

#### Storage tray:

- > For spare fibres

#### Dimensions (h x w x d):

- > XOK 103: 560 x 230 x 100 mm
- > XOK 107: 560 x 230 x 140 mm
- > XOK A3: 560 x 230 x 140 mm

Content is subject to changes acc. to current product development and or any changes to standards.

| Joint closure model | Cable port placement      | Splices max. numbers | Prysmian order no. |
|---------------------|---------------------------|----------------------|--------------------|
| XOK 1030            | 2 ports on short end      | 24 splices           | XJTSC00839         |
| XOK 1030            | 2 ports on short end      | 48 splices           | XJTSC00840         |
| XOK 1030            | 2 ports on short end      | 96 splices           | XJTSC00842         |
| XOK 10304           | 2 port on both short ends | 24 splices           | XJTSC00843         |
| XOK 10304           | 2 port on both short ends | 48 splices           | XJTSC00844         |
| XOK 10304           | 2 port on both short ends | 96 splices           | XJTSC00845         |
| XOK 10305           | 3 port on short end       | 24 splices           | XJTSC00846         |
| XOK 10305           | 3 port on short end       | 48 splices           | XJTSC00847         |
| XOK 10305           | 3 port on short end       | 72 splices           | XJTSC00848         |
| XOK 10305           | 3 port on short end       | 96 splices           | XJTSC00849         |
| XOK 10307           | 3 port on long end        | 24 splices           | XJTSC00850         |
| XOK 10307           | 3 port on long end        | 48 splices           | XJTSC00851         |
| XOK 10307           | 3 port on long end        | 96 splices           | XJTSC00852         |
| XOK 10707           | 3 port on long end        | 192 splices          | XJTSC01064         |
| XOK 10307A          | 3 port on long end        | 24 splices           | XJTSC00853         |
| XOK 10307A          | 3 port on long end        | 48 splices           | XJTSC00854         |
| XOK 10307A          | 3 port on long end        | 96 splices           | XJTSC00855         |
| XOK 10707A          | 3 port on long end        | 192 splices          | XJTSC01065         |
| XJTSC00919          | 3 port on long end        | Up to 192 splices    | XOK A3             |
| XJTSC01247          | 4 ports on long end       | Up to 129 splices    | XOK A4             |

## CONNECTIVITY

# PK-300 TERMINATION BOX

## INDOOR WALL MOUNTED METALLIC IP54



### Application

Robust and dust-proof cabinet with lockable door for the termination, branching and distribution of fibre optic cables in telecommunication, CATV and LAN networks under dry indoor conditions.

Suitable for wall-mounted installations with small or intermediate numbers of fibres. The construction of the box is clear and simple and independent of cable constructions and is easy to install, maintain and upgrade.

A patch panel divides the box into splicing and cross-connection sections. Cross-connection section has cable entrances to both up and down, directions. Two cable inlets on the top and on the bottom can be connected to one wide inlet that gives the possibility to bring in and take out the cable from the box without cutting all the fibres.

The cabinet is delivered with frame and cover, mounting and grounding bar, splice tray, entrance material for one outdoor cable, stress relief bars for 24 pcs. of diameter 2 mm patch cords of 2 pcs, cable ports and patch panel.

Additional materials such as adaptors, pigtailed, splice protectors and grounding parts must be ordered separately.

### Construction

#### Termination box:

- > Steel plate
- > Powder painted
- > Wall mountable
- > Dust-proof
- > Patch panel divider
- > Splice section with separate door
- > Cross-connection section

#### Entry ports to splicing section:

- > 6 cable entry port in total
- > 3 on top and 3 on bottom

#### Entry ports to cross-connection section:

- > Entry plates
- > In up and down direction

#### Splice section capacity:

- > 5 trays x 24 splices = 120 splices

#### Patch panel capacity:

- > 48 connection adapters
- > SC, LC-D (LC-duplex) or ST/FC\*D

#### Sealing:

- > Rating of IP54

#### Dimensions (h x w x d):

- > 400 x 480 x 155 mm

#### Weight:

- > 11 kg

Content is subject to changes acc. to current product development and or any changes to standards.

| Product type | Special feature | Prysmian order no. |
|--------------|-----------------|--------------------|
| PK-300       | SC              | XCPSC01559         |
| PK-300       | ST/FC*D         | XCPSC01560         |
| Splice tray  | KT-1412/24      | XJTSC00884         |

## CONNECTIVITY

# PK-100 TERMINATION BOX

## INDOOR WALL MOUNTED METALLIC



### Application

Robust metallic termination box suitable for indoor installations with splicing, cable branching and cross connection functions.

Capacity for 48 splices and 12 SC, LC-D (LC-duplex), ST or FC\*D (D-hole) adapters. In addition there is space for two more splice trays with holder for 24 splice protectors (heat shrinkable) per tray.

The box has three cable inlets on the bottom with maximum cable diameter of 20 mm. Metallic cables can be grounded with earthing screw on the outer surface of the bottom part.

The distribution box is delivered with metallic box, bottom and cover, mounting and grounding bar, splice tray KT-1412 for 12/2 and entrance material KT-1016 with mechanical seal for one cable.

Additional materials such as adaptors, pigtails, splice protectors, additional splice trays and grounding parts must be ordered separately.

### Construction

#### Distribution box:

- > Metal
- > Powder painted
- > Splicing section
- > Splice tray - room for 2 more
- > Cross-connection section
- > Cable branching
- > Cover
- > Bottom

#### Entry ports:

- > 3 on the bottom
- > Max. cable diameter 20 mm

#### Splice section capacity:

- > 48 fusion splices
- > Space for 2 more splice trays
- > Heat shrinkable

#### Cross-connection capacity:

- > 12 connection adaptors
- > SC, LC-D (LC-duplex), ST or FC\*D (D-hole) adapters

#### Grounding:

- > Earthing screws on the bottom

#### Dimensions (h x w x d):

- > 350 x 210 x 66 mm

#### Weight

- > 3.0 kg

Content is subject to changes acc. to current product development and or any changes to standards.

| Product type      | Special feature                            | Prysmian order no. |
|-------------------|--------------------------------------------|--------------------|
| Termination box   | PK-100 SC                                  | XCPSC01555         |
| Termination box   | PK-100 ST/FC*D                             | XCPSC01556         |
| Splice tray       | KT-1412/24                                 | XJTSC00884         |
| Entrance material | KT-1016 with mechanical seal for one cable | XJTSC00879         |

CONNECTIVITY

# PK-100A TERMINATION BOX

## INDOOR WALL MOUNTED METALLIC



**Application**

Robust metallic termination box suitable for indoor installations with splicing, cable branching and cross connection functions.

Capacity for 24 splices and 12 SC or LC-D (LC-duplex) adaptors.

The box has two cable inlets on the bottom with maximum cable diameter of 20 mm. Metallic cables can be grounded with earthing screw on the outer surface of the bottom part.

The distribution box is delivered with metallic box, bottom and cover, mounting and grounding bar, splice protector holder for 24 splices and entrance material KT-1020 with mechanical seal for one cable.

Additional materials such as adaptors, pigtails, splice protectors, additional entry material and grounding parts must be ordered seperately.

**Construction**

**Distribution box:**

- > Metal
- > Powder painted
- > Splicing section
- > Cross-connection section
- > Cable branching
- > Cover
- > Bottom

**Entry ports:**

- > 2 on the bottom
- > Max. cable diameter 20 mm

**Splice section capacity:**

- > 24 fusion splices
- > Heat shrinkable

**Cross-connection capacity:**

- > 12 connection adaptors
- > SC, LC-D (LC-duplex) adaptors

**Grounding:**

- > Earthing screws on the bottom

**Dimensions (h x w x d):**

- > 160 x 360 x 50 mm

**Weight**

- > 1.9 kg

Content is subject to changes acc. to current product development and or any changes to standards.

| Product type      | Special feature                            | Prysmian order no. |
|-------------------|--------------------------------------------|--------------------|
| Termination box   | PK-100A SC                                 | XCPSC01555         |
| Entrance material | KT-1020 with mechanical seal for one cable | XJTSC00880         |

## CONNECTIVITY

# PK-107 TERMINATION BOX

## OUTDOOR METALLIC SMALL



### Application

Robust metallic termination box suitable for outdoor installations with a small number of fibres. No need for extra protection of fibres when using central tube type optical cables.

Capacity for 12 splices and 2 SC-D or LC-Q (LC-quad) adapters. Suitable for installation inside traffic signs and display poles.

The box has three cable inlets on the bottom with maximum cable diameter of 11 or 16 mm. Metallic grounding of two cables is possible.

The distribution box is delivered as a metallic cabinet with a bottom and cover, adapter plate, wall fixing accessories, mounting and grounding bar, splice protector holder for twelve 12 splice protectors and entrance material for three cables and two heat shrinkable tubes and one mechanical seal.

Additional materials such as adapters, pigtails, splice protectors and grounding parts must be ordered separately.

### Construction

#### Distribution box:

- > Metal - aluminium
- > Powder painted
- > Adaptor plate
- > Splice protector holder
- > Cover
- > Bottom
- > Wall fixing accessory

#### Entry ports:

- > 3 on the bottom
- > Max. cable diameter 1 x 11 or 2 x 16 mm
- > 2 heat shrinkable and 1 mechanical

#### Splice protection capacity:

- > 12 splices protectors
- > Heat shrinkable

#### Cross-connection capacity:

- > 2 connection adapters
- > SC-D or LC-Q

#### Grounding:

- > Possible for two metallic cables

#### Dimensions (h x w x d):

- > 336 x 88 x 40 mm

#### Weight

- > 0.7 kg

Content is subject to changes acc. to current product development and or any changes to standards.

| Product type    | Special feature | Prysmian order no. |
|-----------------|-----------------|--------------------|
| Termination box | PK-107          | XJTSC00861         |



## CONNECTIVITY

# PK-200 TERMINATION BOX

## INDOOR METALLIC WALL MOUNTED



### Application

Robust metallic termination box suitable for indoor installations with splicing, cable branching and cross connection functions.

Capacity for 96 splices and 24 SC, LC-D (LC-duplex), ST or FC\*D (D-hole) adapters.

The box has three cable inlets on the bottom with maximum cable diameter of 20 mm. Grounding of metallic cables is possible via earthing screws on the outer surface of the bottom part.

The termination box is delivered with bottom and cover, mounting and grounding bar, one splice tray KT-1412/24 for 24 splices and entrance material KT-1016 with mechanical seal for one cable.

Additional materials such as adaptors, pigtails, splice protectors, splice tray KT-1412, entrance material KT-1016 and grounding parts must be ordered separately.

### Construction

#### Distribution box:

- > Metal
- > Powder painted
- > Mounting and grounding bar
- > One splice tray (space for 2 in total)
- > Cover
- > Bottom

#### Entry ports:

- > 3 on the bottom
- > Max. cable diameter 20 mm
- > Heat shrinkable

#### Splice tray capacity:

- > Up to 4 splice trays
- > Holder for 24 splice protectors per tray
- > Heat shrinkable

#### Cross-connection capacity:

- > 24 connection adaptors
- > SC, LC-D (LC-duplex), ST or FC\*D (D-hole)

#### Grounding:

- > Possible to ground metallic cables
- > Earthing screws on the bottom

#### Dimensions (h x w x d):

- > 400 x 210 x 120 mm

#### Weight

- > 3.5 kg

| Product type           | Special feature                            | Prysmian order no. |
|------------------------|--------------------------------------------|--------------------|
| Termination box PK-200 | SC                                         | XCPC01557          |
| Termination box PK-200 | ST/FC*D                                    | XCPC01558          |
| Splice tray            | KT-1412/24                                 | XJTSC00884         |
| Entrance material      | KT-1016 with mechanical seal for one cable | XJTSC00879         |

# Railway Main Line Cables

## Cables with reduction factor

Parallel laid railway cables on electrified tracks using alternating current or under high voltage power lines are exposed to the influence electromagnetic fields. These electromagnetic fields induce current in the cables, which can lead to disturbances and destruction of the equipment connected to them as well as present a hazard to life and limb. In order to reduce this influence to a non-hazardous level, the cables are provided with a metallic shield according to their cross-section. This shield has to be earthed on both sides of the cable.

The measure of quality used to shield cables in railway applications is referred to as the reduction factor. The reduction factor is the ratio of induced tension with shielding to the induced tension without shielding. A reduction factor of 1 would mean "no shielding effect". A reduction factor of 0.5, for example, would mean a reduction of the induced tension by one half.

The effect of shielding of the materials used (copper, steel, aluminium, etc.) is dependent on the conducting cross-section of shielding as well as the frequency of the interfering signal.

Depending upon the local circumstances, the cable design and hence the resultant reduction factor can be optimised to best match the expected field strength along the railway track. A typical description for the request for a cable protected against inductive interference shall include disturbing frequency and field intensity as well as the requested reduction factor. For example:

- Reduction factor < 0.5 at 16.7 Hz in the range of 80 – 150 V/km or
- Reduction factor < 0.3 at 50 Hz in the range of 80 – 250 V/km.

The tension induced in the cable increases with the length the cable is exposed to the electrical field. A cable which is exposed over a length of 2000 m to the field can require a lower (better) reduction factor than the same cable, which is only exposed to the induced field over a length of 1000 m.

The calculation of the actually required reduction factor is very complicated and depends on a multitude of different parameters:

- Distance of the cable to be shielded from the interfering cable (overhead line...),
- Type of installation (underground, in conduits, on the ground...),
- Characteristics of the ground,
- etc.

A respective calculation of the required reduction factor can only be carried out by experts. The cable manufacturer then develops the correct cable design based on the given factors.

As a supplier of cables for railway applications and development partners of well-known European railway operators of long standing, We are pleased to develop the right cable design for you according to your needs.

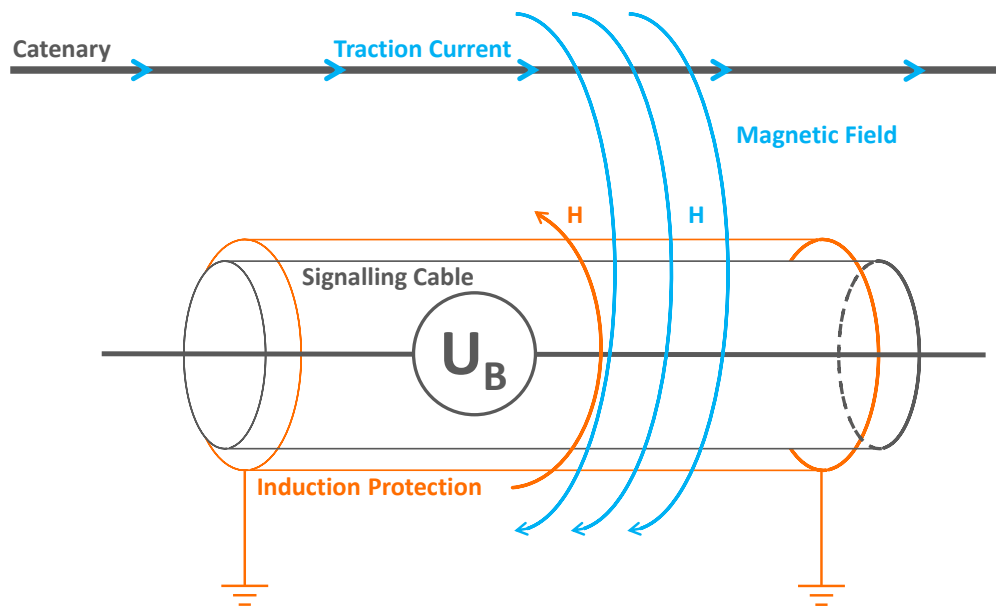

Picture: Magnetic field compensation by inductive protection



Picture: Cable AJ-2Y(L)2YDB2Y 10x4x1.4 mm S (H45) rk 600 of Deutsche Bahn with protection against inductive interference

# Railway Main Line Cables

## Requirements for fire characteristics of cable installations in tunnels or stations

Prysmian provides a complete product range of cables and circuits for the railway infrastructure sector. We also take into consideration the special requirements needed for laying cables in closed environments.

Most railway infrastructure operators specify cables with a black polyethylene (PE) outer sheath for use in the open air. PE is extremely robust and resistant, has very good UV resistance due to the black colouring and guarantees a cable life of about 35 years. PE is halogen-free and burns with low smoke emissions without releasing toxic gases.

In closed areas and narrow spaces, in applications such as tunnels or railway stations, the requirements for the cables are very demanding.

Even though PE is halogen-free and burns with low smoke, it is not recommended for such applications. PE is not self-extinguishing and contributes to further propagation of fire. The fire can penetrate into adjacent rooms and cause more damage. Cables with PVC outer sheath are no alternative either. Although PVC is flame retardant and usually self-extinguishing, it burns producing dark soot and releases toxic gases.

The ideal materials combine the advantages of PE and PVC, are halogen free, produce little smoke, and are flame retardant and self-extinguishing. Such materials are manufactured, refined and improved in Prysmian's material laboratories.

Known halogen-containing materials are, for example, chloroprene rubber (CR), ethylene tetrafluoroethylene (ETFE), perfluoroethylene propylene (FEP) or polyvinyl chloride (PVC). Halogen-free materials are, among others, silicone rubber (SIR), polyamide (PA), ethylene propylene polymers (EPR), thermoplastic elastomers (PE) or polyethylene (PE).

There are European and international standards regarding the unique and comparable classification of flammability properties of cables. We want to briefly introduce to you the most important test procedures.

# Fire testing

## **EN/IEC 60332-1**

(Tests on electric and optical fibre cables under fire conditions: test for vertical flame propagation for single insulated wire or cable)

The flame propagation is tested according to IEC 332-1 on a single cable. A vertical sample of cable about 600 mm in length is exposed to a flame for 60 s and/or 120 s in an area 100 mm above the lower end with a 1 kW Bunsen burner. After removing the burner, the flame must self-extinguish. The zones of the cable damaged by the flame should not reach to the upper end of the cable. The flaming time is dependant on the diameter of the cable.

Comparable tests are DIN VDE 0482-332-1-2, EN 50265-2-1, NF C 32-070 C2, BS 4066-1.



## **EN/IEC 60332-3**

(Tests on electric and optical fibre cables under fire conditions: test for vertical flame spread of vertically mounted bunched wires or cables)

The test for the spread of the flame with an array of several cables, i.e. a bunch of cables, is normally carried out according to IEC 332-3 (EN 50266-2, test method A, B, C or D – for use of different volumes of non-metallic materials).

The test specimens, mounted in a vertical frame, are exposed to a flame over a length of 3600 mm starting in the lower section using a special burner with a high output. During and/or after exposure to the intensive flame for 20 and/or 40 minutes, the cables may not continue to burn to their upper end.

Comparable tests are DIN VDE 0482-266-2-4, EN 50266, NBN C30-004 Cat. F2, BS 4066-3.





# Railway Main Line Cables

## IEC 331

(Cable with insulation integrity)

A horizontal cable sample is exposed to a flame over a width of 1200 mm with a flame temperature of at least 750 °C for a recommended duration of at least 90 minutes. The cable is connected up electrically and under tension. During flaming and a cooling down time of an additional 15 minutes, no short circuiting or interruption of the current may arise.

Comparable tests are EN 50200, EN 50263, NF C 32070 CR1, BS 6287.

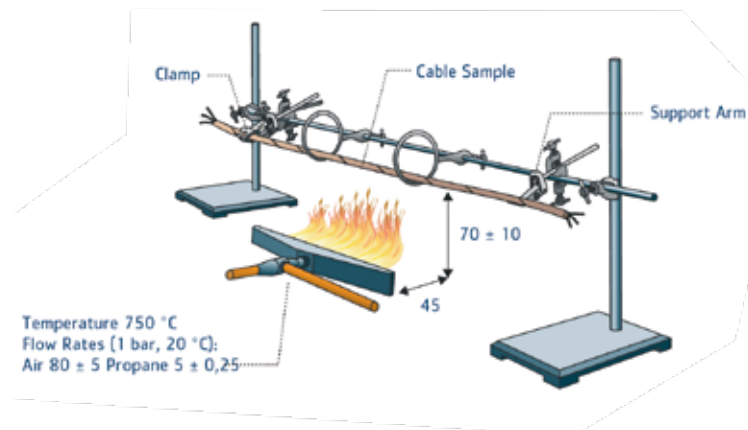

## DIN 4102 part 12

(Cable with functional integrity – system testing of cable and the cable mounting system)

This test is very extensive. As it is a test of the system which includes the cable and the cable mounting system, the product to be tested is completely walled into a closed space. The cables are connected up electrically and are kept under tension during the test. The entire room is set alight with a defined temperature unit curve. After at least 30 minutes flame exposure, neither short-circuiting or interruption of circuit may arise. It is extremely difficult to pass the test, as the cable mounting system has a considerable influence on the result. Cable clips, ducts or conductors exert mechanical loads on the cable, as the material changes during flaming: cable ducts start to bend through the load exerted by the cable and the originally smooth cable suddenly hangs down at several points. This mechanical change of position of the burned cable can lead to interruption or short-circuiting.

**IEC 61034**

(Measurement of smoke density of cables burning under defined conditions)

A plastic sample is burned under controlled conditions. In this way, the light transmission through the combustion gases which arise is measured.

Comparable tests are DIN VDE 0482-286-1 and -2, NFX 10702, BS 7622-2.

**IEC 60754-1**

(Test on halogen acid gases evolved during combustion of materials from cables)

A plastic sample is burned under controlled conditions. In this way, the smoke gases are measured for their halogen content.

Comparable tests are DIN VDE 0482-267-2-1 and EN 50267-2, NF C 20454, BS 6425-1.

**IEC 60754-2**

(Test on acidity of gases evolved during combustion of materials from cables)

A plastic sample is burned under controlled conditions. In this way, the pH-value and the conductivity of the smoke gases are measured.

A comparable test is DIN VDE 0276-604.

With the exception of the small fire test according to EN/IEC 60332-1, the cable is normally destroyed during the flame test. Although no short-circuiting or interruptions should arise, it is difficult to speak about defined electrical values such as operating capacity or characteristic impedance. In this case we are talking about either: current flowing or not. This may in reality be adequate for loudspeaker announcements or sprinkler systems. Control and safety technology using electronic interlocking is during or after a cable fire, if at all, hardly still sensible and feasible. Under these circumstances, the need to maintain fire testing standards according to EN/IEC 60331 (insulation integrity) and/or DIN 4102 part 12 (functional integrity) makes little sense for railway signalling cables for electronic interlocking.

# Railway Main Line Cables

## Construction Product Regulation

Since 01/07/2013, the “Construction Product Directive” (CPD) in the EU has been replaced by the “Construction Product Regulation” (CPR) and is thus valid law in all member states of the EU. The CPR and/or the building product directive (BPVo) affects all cables which are intended for permanent installation in a building. Products have to fulfil requirements in terms of behaviour and/or resistance in the case of fire.

CPR itself does not define any performance requirements regarding the affected products. The definition of safety requirements remains the responsibility of the national authorities.

CPR has introduced binding performance requirements (Declaration of Performance, DoP) and the corresponding CE-mark for labelling the products. The cable’s fire characteristics shall be marked in the future with a combination of different classes (The index “ca” stands for “cable”):

|                               |                                                                              |                          |
|-------------------------------|------------------------------------------------------------------------------|--------------------------|
| CPR classes are:              | $A_{ca}$ , $B1_{ca}$ , $B2_{ca}$ , $C_{ca}$ , $D_{ca}$ , $E_{ca}$ , $F_{ca}$ | (see table to the right) |
| Smoke classes are:            | s1, s1a, s1b, s2, s3                                                         | (EN 50399/EN 61034-2)    |
| Acidity classes are:          | a1, a2, a3                                                                   | (EN 60754-2)             |
| Flaming droplets classes are: | d0, d1, d2                                                                   | (EN 50399)               |

The CPR has no class or guideline for railway cables laid in exposed outdoor areas. These cables may continue to be designed, produced and installed as previously. For railway cables in tunnels or train stations, the relevant cable manufacturers associations recommend a classification according to the EU regulation (1303/2014), clause 4.2.2.4: “In case of fire, exposed cables shall have the characteristics of low flammability, low fire spread, low toxicity and low smoke density. These requirements are fulfilled when the cables fulfil as a minimum the requirements of classification  $B2_{ca}$ , s1a, a1, as per Commission Decision 2006/751/EC.”

Prysmian Group will observe these obligations and, as far as they do not satisfy existing cable designs, will provide cables and products to the market with the corresponding properties.

| Class            | Test method(s)            | Classification criteria                                                               | Additional classification                                      |
|------------------|---------------------------|---------------------------------------------------------------------------------------|----------------------------------------------------------------|
| A <sub>CA</sub>  | EN ISO 1716               | PCS ≤ 2,0 MJ/kg and<br>PCS ≤ 2,0 MJ/kg and                                            |                                                                |
| B1 <sub>CA</sub> | EN 50399<br>and           | FS ≤ 1.75 m and<br>THR1200s ≤ 10 MJ and<br>Peak HRR ≤ 20 kW and<br>FIGRA ≤ 120 Ws-1   | Smoke production and Flaming<br>droplets/particles and Acidity |
|                  | EN 50265-2-1              | H ≤ 425 mm                                                                            |                                                                |
| B2 <sub>CA</sub> | EN 50399<br>and           | FS ≤ 1.5 m; and<br>THR1200s ≤ 15 MJ; and<br>Peak HRR ≤ 30 kW; and<br>FIGRA ≤ 150 Ws-1 | Smoke production and Flaming<br>droplets/particles and Acidity |
|                  | EN 50265-2-1              | H ≤ 425 mm                                                                            |                                                                |
| C <sub>CA</sub>  | EN 50399<br>and           | FS ≤ 2.0 m; and<br>THR1200s ≤ 30 MJ; and<br>Peak HRR ≤ 60 kW; and<br>FIGRA ≤ 300 Ws-  | Smoke production and Flaming<br>droplets/particles and Acidity |
|                  | EN 50265-2-1              | H ≤ 425 mm                                                                            |                                                                |
| D <sub>CA</sub>  | EN 50399<br>and           | THR1200s ≤ 70 MJ; and<br>Peak HRR ≤ 400 kW; and<br>FIGRA ≤ 1300 Ws-1                  |                                                                |
|                  | EN 50265-2-1              | H ≤ 425 mm                                                                            |                                                                |
| E <sub>CA</sub>  | EN 50265-2-1              | H ≤ 425 mm                                                                            |                                                                |
| F <sub>CA</sub>  | no performance determined |                                                                                       |                                                                |

Table: Overview of the CPR classifications

# Railway Main Line Cables

## Transport and storage of cable drums

Even if cable and drum look very strong, there are certain rules to follow to avoid damage of the cable and an accompanying impairment of mechanical and electrical characteristics.

### Transport and storage of cable drum

It is possible to store cable drums outdoors. When storage has occurred in heated rooms, a minimum 24-hour acclimatisation period must be observed before installation (possible condensation build-up in the cable!).

For outdoor storage the ground must be even and clean. Stones or bumps in the ground should be removed or smoothed out. Damage to the wound goods/cable should be avoided at all costs.

Cables should be secured against accidental rolling away. Under no circumstances should the drum flange of neighbouring cables touch any wound goods.

Cable drums should always be stored and transported standing on both flanges.

They should not be pushed along the ground standing on the flanges. It is possible that the strength of the cable drum would then no longer be guaranteed.

Observe the rolling direction. The arrow printed on the drum flange indicates the rolling direction so that the wound goods do not become loose.

Always uncoil the cable at a tangent, never over the flange, since the torsion thus resulting would damage the cable and laying would not be possible.

### Cable ends

Finally it remains for us to point out the necessity of having faultless cable ends. Pressure-tight and impermeable cable ends are particularly essential for cables which are not longitudinally water-proof, as well as for cables which are insulated with paper, cellular-PE and foam-skin-PE. Carelessness in this area can lead to moisture penetration which is accompanied by a drastic deterioration in the electrical transmission rate. Power failures and expensive replacement work are the result.

Pressure-tight and impermeable cable ends can be achieved, for example, through the use of synthetic sealing resin or compressed air sealing stoppers.





# Important physical characteristics

## Temperature range

The temperature range of the cable is of great importance for both the user and fitter. After all the cable is meant to function equally well in cold and hot temperatures. It is particularly during the fitting process that powerful mechanical forces act on the cable. The plastic used serves as the limiting element for the possible temperature range. At overly warm temperatures the plastic becomes very soft and can change into a thermoplastic state (up to melting point), which causes irreversible changes in the cable.

At very cold temperatures, however, the material stiffens and becomes hard and inflexible. Here, too, irreparable damage can occur.

Tears in the sheath allow dampness and moisture in and impair the transmission rate. Details about the permissible temperature range during laying and use (following successful fitting) can be found in the information sheets of the cable manufacturer. Since the mechanical strain on the cable in its laid form is significantly less, the permissible temperature range is greater than the range valid for the installation period.

## Bending radius

Regarding the bending radius we distinguish between multiple and single bending (shaping into the final position).

Multiple bending occurs mainly during the laying process. Cables are laid under tension around deflector rolls. The particular stress of multiple bending lies in the alternating stress on the materials, which can be stretched several times as well as compressed during the laying process.

To prevent permanent damage there are prescribed minimum bending radii of, for example, 10 x cable external diameter for multiple bending.

The stress on the material during final bending is not characterised by alternating stress. The cable is bent into form a final time and stays in this position for the duration of its use. The minimum bending radius in this case is, for example, 7.5 x cable external diameter. During final bending the cable can, therefore, be bent more tightly.

Exact minimum bending radii for specific cables can be found in the information sheets of the cable manufacturer.

## Tension

During laying of the cable particular attention must be paid to the maximum possible tension. The cable is very quickly damaged by the use of too much force and must then be replaced. The maximum possible tension depends in the first place on the overall cross section and the tensile strength of the conducting materials used.

For cables with steel tape or copper wire spiral armouring it is the internal copper conductors alone which determine the maximum tension! The armouring has no influence on the maximum tension or can possibly reduce it through additional weight. For armouring with steel or steel profile wires, however, the tension is determined solely by the steel and steel profile wires.

## Cable weight

The cable weight of larger cable dimensions can take weights of up to more than 10 t/km (without the reel!).

# Railway Main Line Cables

## Certifications and compliance

### **Certifications of Railway and Infrastructure Authorities**

Being a very complex system with a high safety integrity level, railway products are subject to detailed requirements and strong supervision. Many railway infrastructure operators issued dedicated cable specifications which require homologation and frequent auditing. Prysmian Railway Cables are designed and produced according to a number of railway cables standards, like DB, SBB, ÖBB, SNCF, TCDD, ADIF/RENFE, RFI, RATP and many more in Europe and around the globe. High quality manufacturing processes, many decades of experience in cable design and engineering as well as intense testing procedures guarantee state-of-the-art cable products and satisfied customers worldwide.

### **REACH (Registration, Evaluation and Authorisation of Chemicals)**

Adopted on December 18th, 2006, the Regulation of the European Parliament and the European Union Council, modernized the European legislation regarding chemical substances, and set up a unique integrated system of chemical substances in the European Union. Its objective is to improve the protection of the human health and of the environment, while maintaining the European chemical industry's competitiveness and strengthening its spirit of innovation. All Prysmian railway cables are REACH compliant.

### **RoHS (Restriction of the use of certain Hazardous Substances in Electrical and Electronic Equipment)**

The RoHS directive aims at restricting the use of certain dangerous substances commonly used in electric and electronic equipment (EEE). Cables concerned by this directive are any cables rated below 250V, which function is the connection or the extension of an EEE to electrical outlet or the connection of two or more EEE to each other. All Prysmian railway cables are RoHS compliant.

### **Management Systems**

- Quality Management System EN ISO 9001:2008
- Environmental Management System EN ISO 14001:2005
- Energy Management System EN ISO 50001:2011

# Our responsibilities

## **Social Responsibility**

Within the social dimension of its business, the Prysmian Group recognises its commitment and responsibility towards the persons who work as part of the Organisation, as well as those who form the local communities in the territories in which the Group is active. Accordingly, consistent with its values, Prysmian constantly seeks to ensure the personal and professional satisfaction of its human resources, and to communicate with and involve local populations, in order to generate value for these important categories of stakeholder.

## **Environmental responsibility**

The Group's commitment to safeguarding the environment and conserving natural resources is expressed not only by the intrinsic characteristics of our products, but also by how our production systems are managed. In particular, the prevention and reduction of their environmental impact is achieved, for example, by the efficient use of natural resources, the optimisation of logistics flows and the responsible management of waste.

During 2015, HSE further consolidated its activities at various levels within the Group (corporate, country or geographical area, business unit, production unit), centralising activities and coordinating the work of the local HSE functions. Group policies for Health, Safety and Environment, as well as the related Operating Procedures and Technical Standards, have been adopted and applied at operating unit level. The HSE function, with support from the Group audit team, periodically checks the effectiveness and proper application of the HSE rules at local level.

The aspects monitored by HSE using indicators include compliance with health and safety at work standards, energy consumption, waste management, water usage and greenhouse gas emissions. In particular, with reference to the greenhouse gas emissions, the Group has begun to collect energy consumption data in order to track both "direct" emissions (deriving from production processes) and "indirect" emissions (deriving from the energy purchased). This system of monitoring and reporting enabled the Group to participate in 2015, once again, in the Carbon Disclosure Project (CDP), which seeks to contribute to the pursuit of the objectives agreed in the Kyoto Protocol regarding the global reduction of greenhouse gas emissions

## **Product responsibility**

Quality and innovation are the hallmarks of Prysmian's approach, both in sectors where the level of technology, the ability to innovate constantly and the commitment to offering high value-added services together establish a differentiated competitive positioning, and in those sectors where products are more standardised, such as medium and low-voltage cables. The Group applies a customer-centric approach, reflecting an ability to anticipate and satisfy the needs of customers with the maximum possible attention.

# Railway Main Line Cables

## References

Prysmian Group has been supplying the railway industry for many decades. We supply all renowned European railway infrastructure companies, often as part of long-term master agreements. Many important projects have been completed in the recent years all around the world, even more are yet to come. There is always our office close to you.

The following excerpt of our success records shall give you an idea about our local and global presence.

### **North Europe:**

- Denmark: ERTMS Signalling Program, Electrification of Danish Railways, Renewal of Danish Rail Infrastructure, Copenhagen Metro and S-Bane, Aarhus Tram
- Finland: Länsi Metro, Helsinki Metro, Rail Safety Project, Electrification of Jyväskylä-Äänekoski Line
- Norway: LKAB Narvik-Kiruna Line, InterCity Project, GSM-R Network for the ERTMS Signalling Program
- Sweden: Renewal of Stockholm Metro
- Latvia: Modernization of LZD-infrastructure

### **Rest of the world:**

- Australia: QueenslandRail, conversion to axle counter detection technology
- Egypt: Cairo – Alexandria line
- Bulgaria: Plovdiv-Burgas line
- Chile: Rancagua project
- Germany: Framework contract and development partner of Deutsche Bahn
- Israel: Ashkelon – Netivot line
- Canada: Toronto Transit Authority
- Croatia: Zagreb Central Station
- Malaysia: Thomson Line project
- Morocco: Casablanca – Tanger line
- Mexico: Metro Monterey
- Saudi Arabia: North-South-Rail project, Mecca Metro
- Switzerland: Framework contract with SBB
- Singapore: Singapore Metro Subaqua Cable
- Spain: Vandellos-Tarragona line, Madrid – Leon – Burgos high speed Line
- Turkey: Ankara-Konya high speed line, Eskisehir – Balıkesir line, Metro Istanbul, Metro Ankara
- USA: JFK Air Train, New York City Transit, Oakland Bay Area Rapid Transit





### **We are here for you**

You are always welcome to contact us directly with technical questions or sales enquires.

### **Contact**

Telephone: +47 32 24 90 00

### **E-mail**

[no-kundesenter@prysmiangroup.com](mailto:no-kundesenter@prysmiangroup.com)

### **Website**

[www.draka.no](http://www.draka.no)  
[www.prysmiangroup.no](http://www.prysmiangroup.no)

### **Draka Norsk Kabel AS**

Postboks 369 Bragernes  
3001 Drammen  
Norway